



MOTOR DATA SHEET

MOTOR PART CODE:

0.1241TCCB14B

FRAME SIZE:

631-4

50Hz

Output (kW)	0.12
Rotation Speed (rpm)	1380
Voltage	230
Full Load Current (A)	1.01
Full Load Torque (Nm)	0.83

Factory Reference	ML631-4
Tst/Tn (times)	2.5
Tmax/Tn	1.65
Noise (dB)	65
Moment of inertia	0.000291377
Type of feet	Not Fitted
Rotation Direction	F / R
Cooling	IC411
Standard	IEC60034
IP Rating	IP55
Allowed Radial Load (N)	409
Bearing (DE)	6201 2RZ C3

Power Factor (cos)	0.95
Tmin/Tn	1.6
Ist/In (Times)	5.5
Net Weight (Kg)	4.1
Housing material	Aluminium
Insulation Class	F
Duty Cycle	S1
Paint	RAL 7024
Ambient Temperature	-20°C to +40°
Starting Method	DOL
Allowed Axial Load (N)	353
Bearing (NDE)	6201 2RZ C3

Motors designed and manufactured in accordance with:

IEC 60034
IEC 60038
IEC 60072
2014/30/EU (EMC)
2014/35/EU (LVD)
2011/65/EU (RoHS 2)

www.tecmotors.co.uk

TEC Electric Motors Ltd. reserves the right to amend or change motor designs or data sheet information

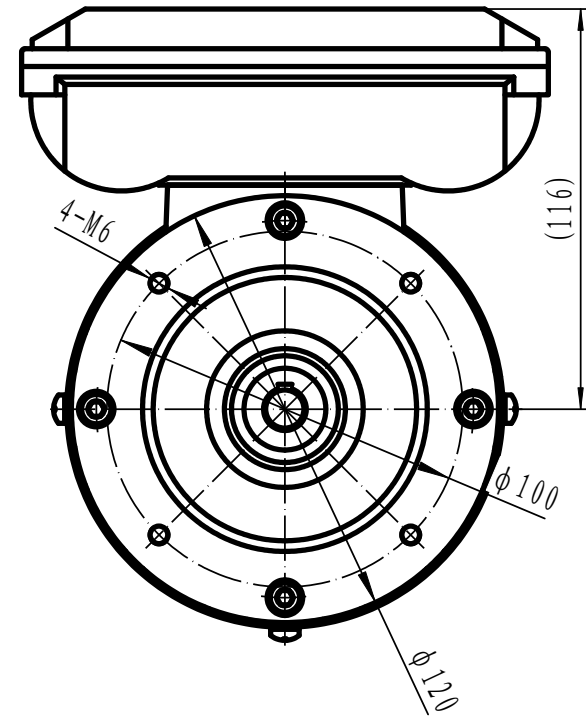
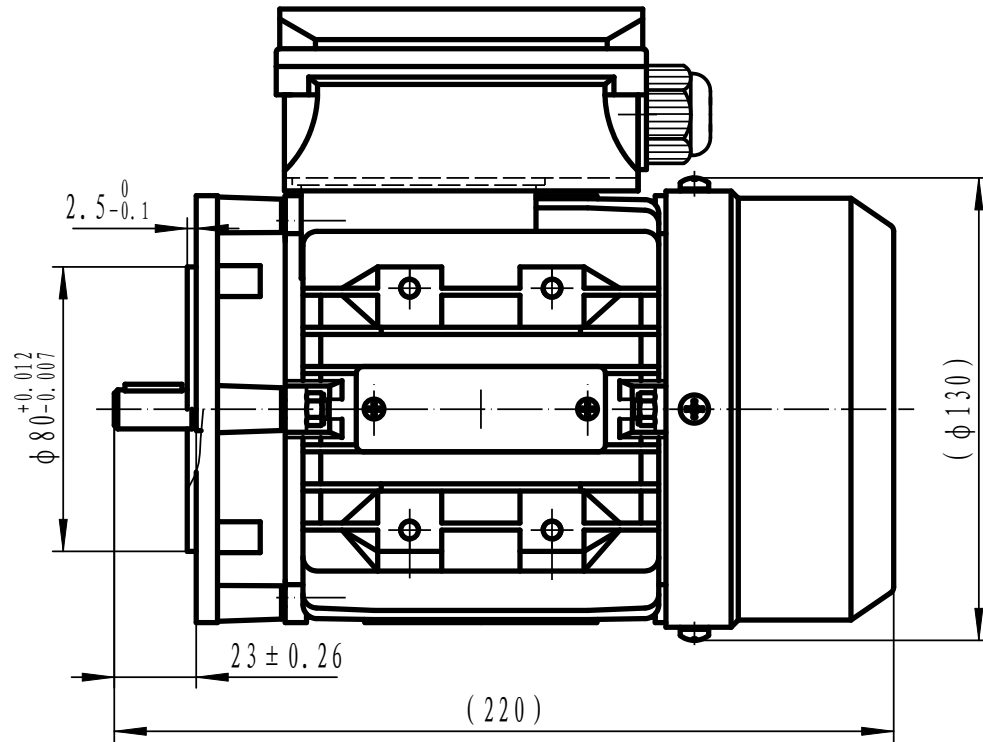
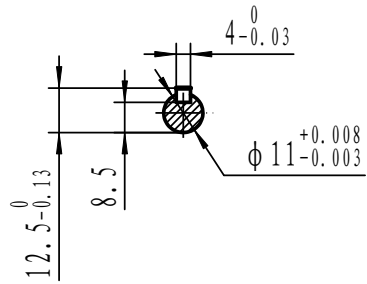

Drawn By	Date
A442313	27/11/2017
Approved by	Date
L. Overton	27/11/2017
Issue No =	Date
A401/001/18	27/11/2017

TCC 63 B14B

