



MOTOR DATA SHEET

MOTOR PART CODE:

0.1861TPCB14

FRAME SIZE:

711-6

50Hz

Output (kW)	0.18
Rotation Speed (rpm)	930
Voltage	230
Full Load Current (A)	1.52
Full Load Torque (Nm)	1.85

Factory Reference	MYT711-6
Tst/Tn (times)	0.65
Tmax/Tn	1.7
Noise (dB)	68
Moment of inertia	0.000585066
Type of feet	Not Fitted
Rotation Direction	F / R
Cooling	IC411
Standard	IEC60034
IP Rating	IP55
Allowed Radial Load (N)	522
Bearing (DE)	6202 2RZ C3

Power Factor (cos)	0.99
Tmin/Tn	0.58
Ist/In (Times)	2.2
Net Weight (Kg)	6.3
Housing material	Aluminum
Insulation Class	F
Duty Cycle	S1
Paint	RAL 7024
Ambient Temperature	-20°C to +40°
Starting Method	DOL
Allowed Axial Load (N)	461
Bearing (NDE)	6202 2RZ C3

Motors designed and manufactured in accordance with:

IEC 60034
IEC 60038
IEC 60072
2014/30/EU (EMC)
2014/35/EU (LVD)
2011/65/EU (RoHS 2)

www.tecmotors.co.uk

TEC Electric Motors Ltd. reserves the right to amend or change motor designs or data sheet information

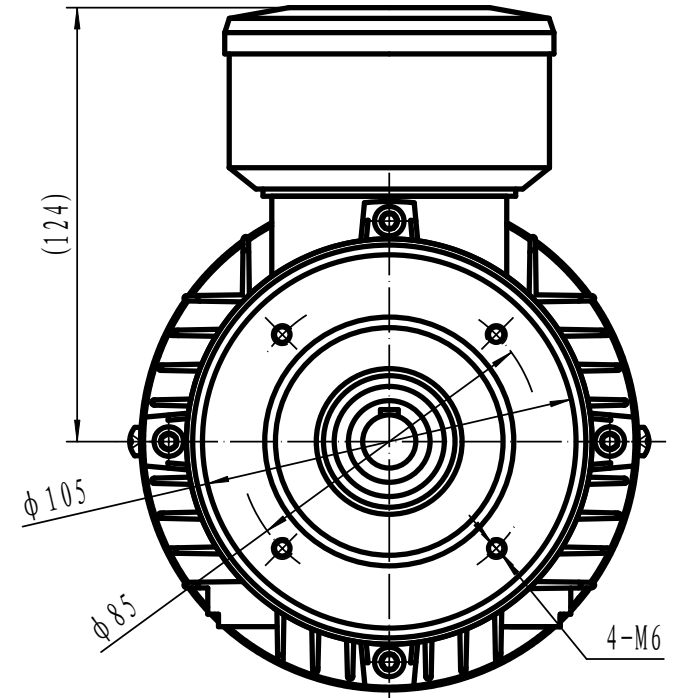
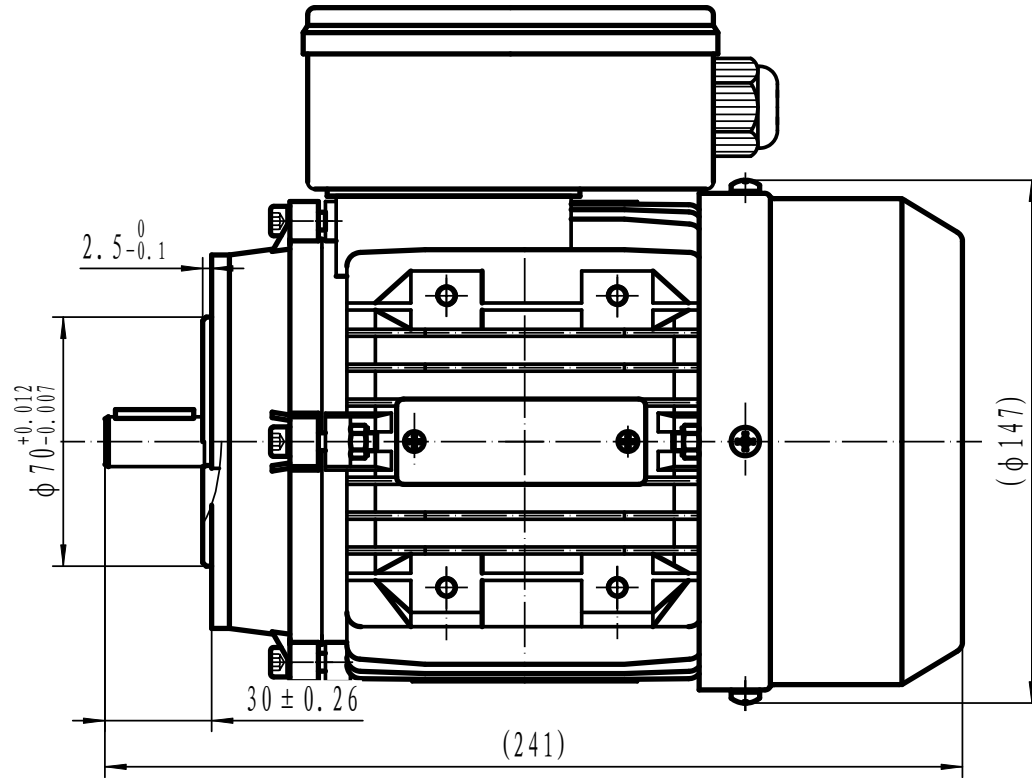

Drawn By	Date
A442313	27/11/2017
Approved by	Date
L. Overton	27/11/2017
Issue No =	Date
TPC01/A001	27/11/2017

TPC 71 B14



www.tecmotors.co.uk