



MOTOR DATA SHEET

MOTOR PART CODE:

0.2521TPCB35

FRAME SIZE:

632-2

50Hz

Output (kW)	0.25
Rotation Speed (rpm)	2750
Voltage	230
Full Load Current (A)	1.71
Full Load Torque (Nm)	0.87

Factory Reference	MYT632-2
Tst/Tn (times)	0.65
Tmax/Tn	1.75
Noise (dB)	70
Moment of inertia	0.000167831
Type of feet	Removable feet
Rotation Direction	F / R
Cooling	IC411
Standard	IEC60034
IP Rating	IP55
Allowed Radial Load (N)	326
Bearing (DE)	6201 2RZ C3

Power Factor (cos)	0.98
Tmin/Tn	0.67
Ist/In (Times)	3.2
Net Weight (Kg)	4.7
Housing material	Aluminum
Insulation Class	F
Duty Cycle	S1
Paint	RAL 7024
Ambient Temperature	-20°C to +40°
Starting Method	DOL
Allowed Axial Load (N)	260
Bearing (NDE)	6201 2RZ C3

Motors designed and manufactured in accordance with:

IEC 60034
IEC 60038
IEC 60072
2014/30/EU (EMC)
2014/35/EU (LVD)
2011/65/EU (RoHS 2)

www.tecmotors.co.uk

TEC Electric Motors Ltd. reserves the right to amend or change motor designs or data sheet information

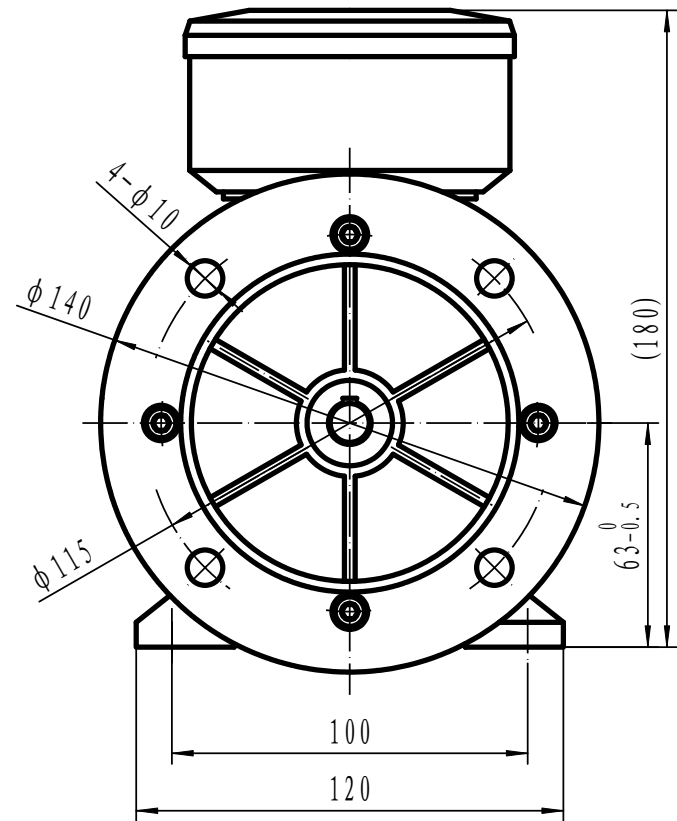
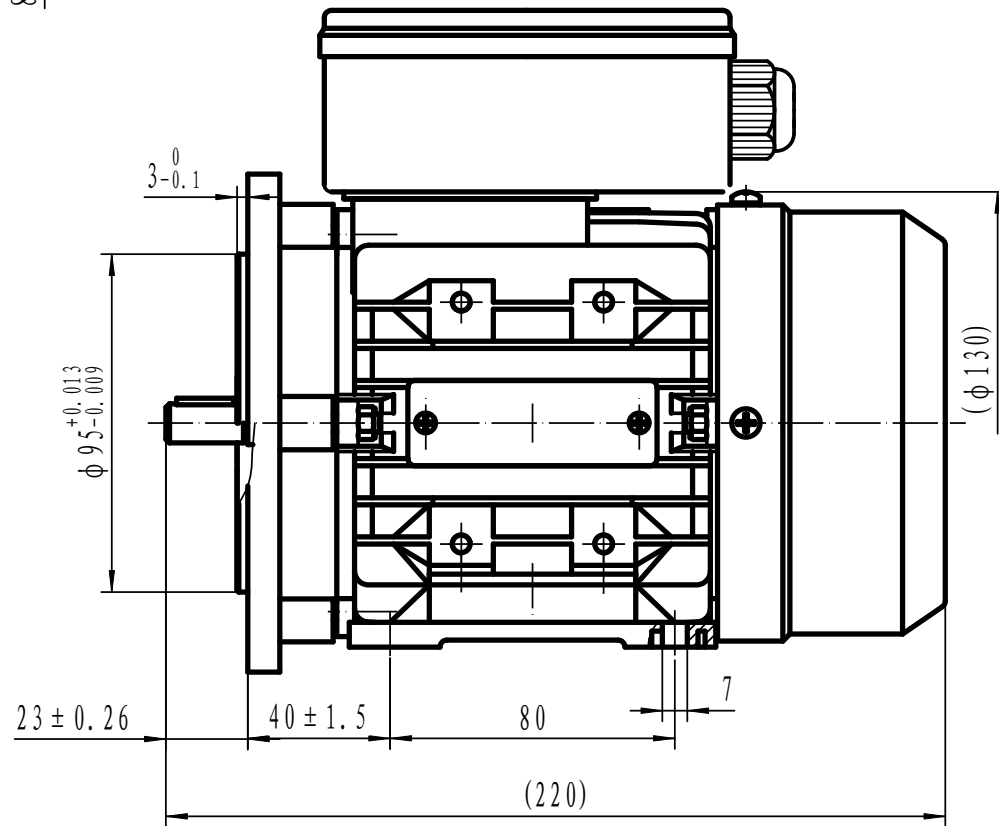
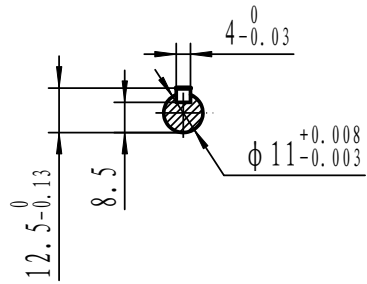

Drawn By	Date
A442313	27/11/2017
Approved by	Date
L. Overton	27/11/2017
Issue No =	Date
TPC01/A001	27/11/2017

TPC 63 B35



www.tecmotors.co.uk