



## MOTOR DATA SHEET

**MOTOR PART CODE:**

**0.5521TCCB34**

**FRAME SIZE:**

**712-2**

**50Hz**

Output (kW)	0.55
Rotation Speed (rpm)	2790
Voltage	230
Full Load Current (A)	3.31
Full Load Torque (Nm)	1.88

Factory Reference	ML712-2
Tst/Tn (times)	2.5
Tmax/Tn	1.8
Noise (dB)	75
Moment of inertia	0.00043685
Type of feet	Removable feet
Rotation Direction	F / R
Cooling	IC411
Standard	IEC60034
IP Rating	IP55
Allowed Radial Load (N)	363
Bearing (DE)	6202 2RZ C3

Power Factor (cos)	0.97
Tmin/Tn	1.6
Ist/In (Times)	6
Net Weight (Kg)	7
Housing material	Aluminium
Insulation Class	F
Duty Cycle	S1
Paint	RAL 7024
Ambient Temperature	-20°C to +40°
Starting Method	DOL
Allowed Axial Load (N)	283
Bearing (NDE)	6202 2RZ C3

*Motors designed and manufactured in accordance with:*

**IEC 60034**  
**IEC 60038**  
**IEC 60072**  
**2014/30/EU (EMC)**  
**2014/35/EU (LVD)**  
**2011/65/EU (RoHS 2)**

[www.tecmotors.co.uk](http://www.tecmotors.co.uk)

TEC Electric Motors Ltd. reserves the right to amend or change motor designs or data sheet information

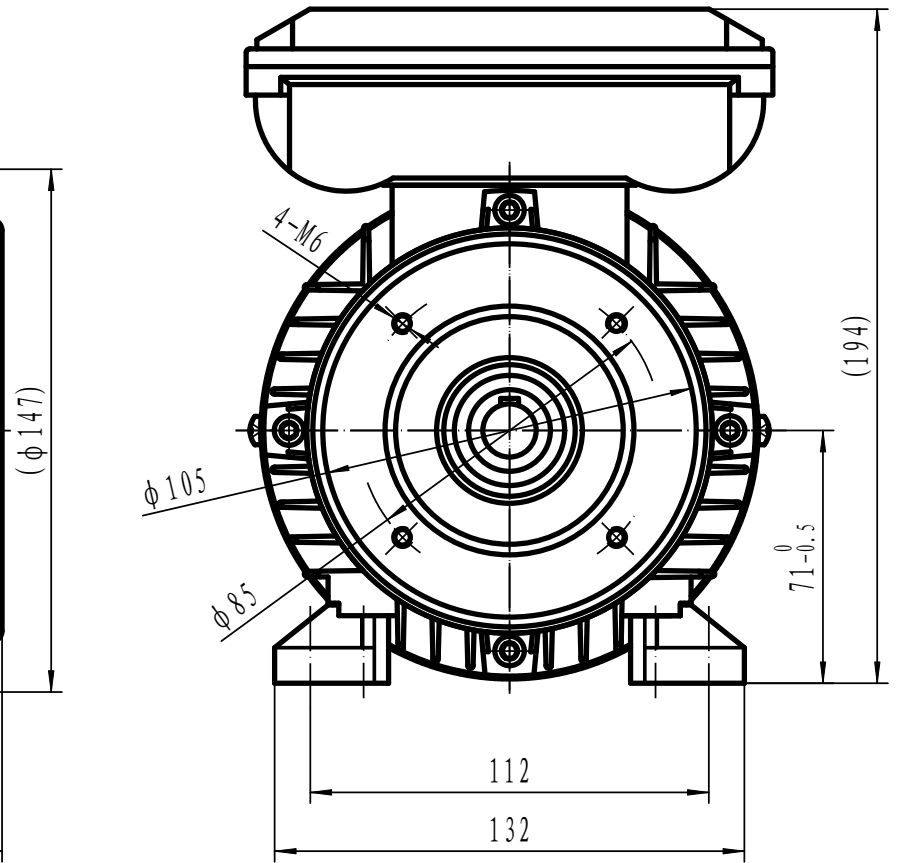
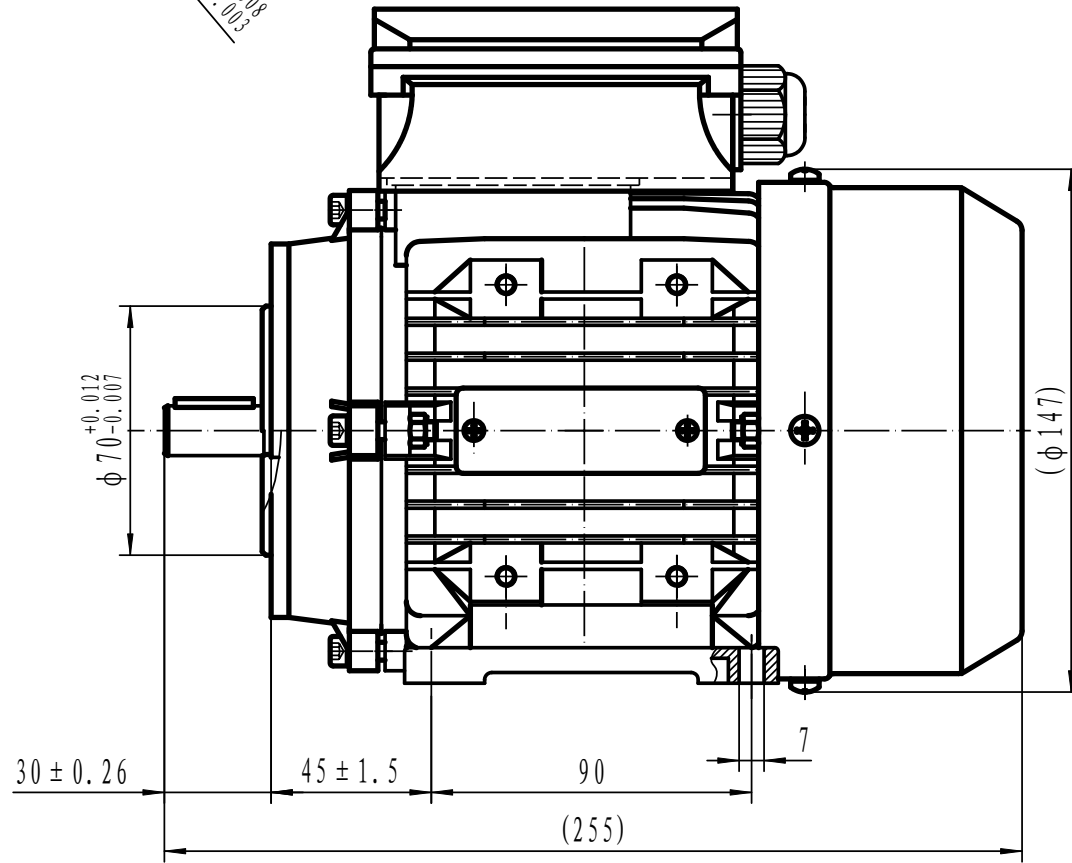
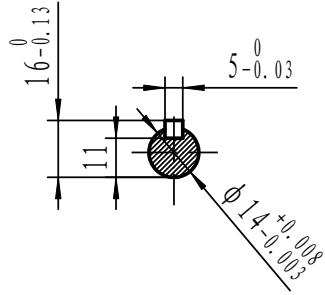

Drawn By	Date
A442313	27/11/2017
Approved by	Date
L. Overton	27/11/2017
Issue No =	Date
A401/001/18	27/11/2017

**TCC 71 B34**



www.tecmotors.co.uk