



BRAKE MOTOR DATA SHEET

MOTOR PART CODE:

0.5523TECAB14-BM

FRAME SIZE:

712-2

	50Hz
Output (kW)	0.55
Rotation Speed (rpm)	2760
Voltage	230/400
Full Load Current (A)	2.46 1.42
Full Load Torque (Nm)	1.90307971

	60Hz
Output (kW)	0.66
Rotation Speed (rpm)	3312
Voltage	276 480
Full Load Current (A)	2.46 1.42
Full Load Torque (Nm)	1.59

Efficiency Data

100%	75%	50%
71	70	64

Factory Reference	MSB712-2
Tst/Tn (times)	2.2
Tmax/Tn	2.4
Noise (dB)	64
Moment of inertia	0.000383688
Type of feet	Not Fitted
Protection	IP55
Rotation Direction	F / R
Cable Glands	1 - M20× 1.5
Paint Colour	RAL 7024
Brake Torque (Nm)	3.5
Brake Voltage	205v DC
Recitifer	Full wave

Power Factor (cos)	0.79
Tmin/Tn	1.6
Ist/In (Times)	6
Net Weight (Kg)	6
Housing material	Aluminum
Insulation Class	F
Thermal Protection	PTC 130°C
Duty Cycle	S1
Cooling	IC411
Ambient Temperature	-20°C to +40°
Bearing Brand	NSK
Bearing (DE)	6202 2RS C3
Bearing (NDE)	6202 2RS C3

Motors designed and manufactured in accordance with:

IEC 60034
IEC 60038
IEC 60072
2014/30/EU (EMC)
2014/35/EU (LVD)
2011/65/EU (RoHS 2)

www.tecmotors.co.uk

TEC Electric Motors Ltd. reserves the right to amend or change motor designs or data sheet information

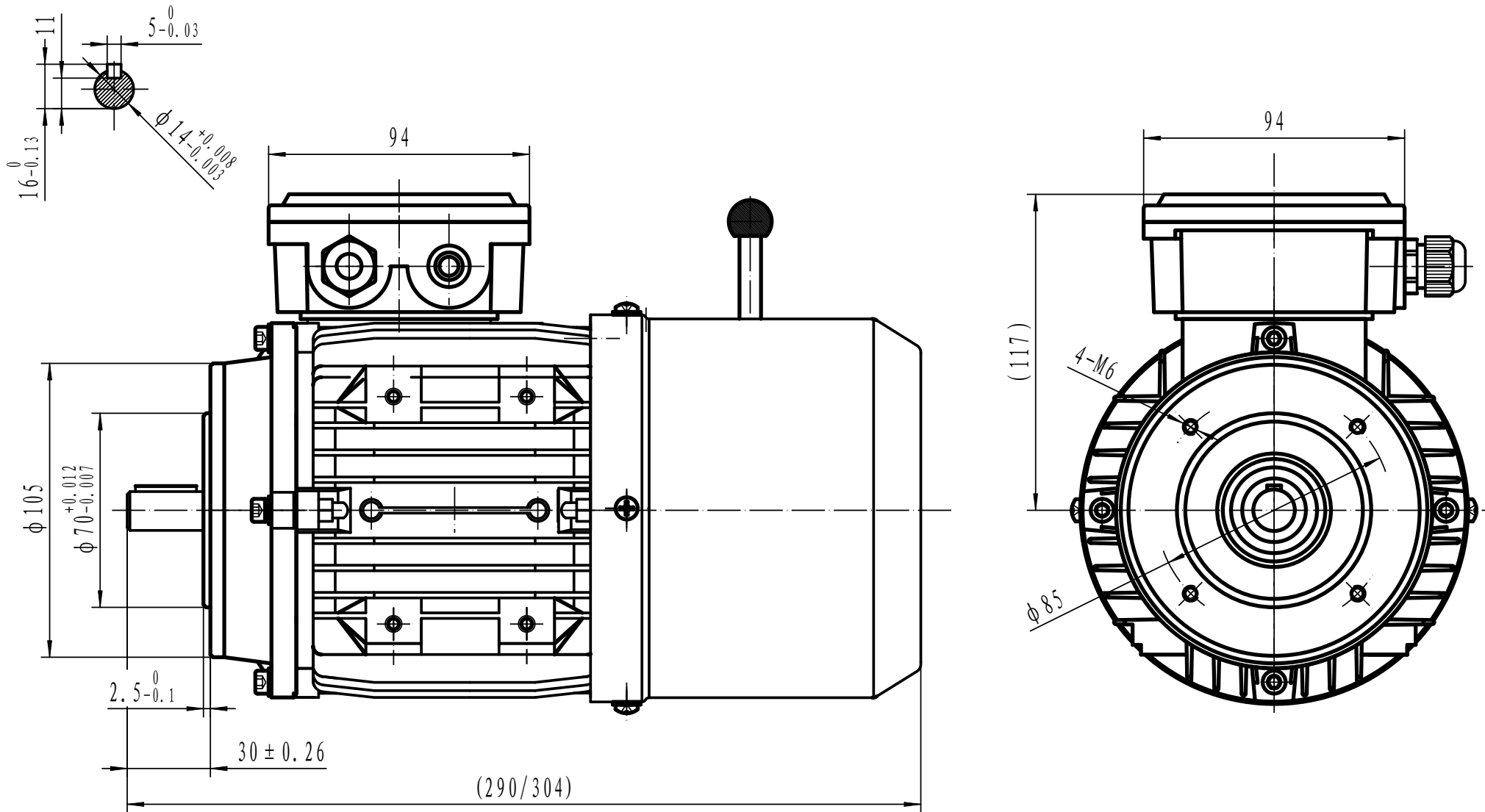

Drawn By	Date
A442313	27/11/2017
Approved by	Date
L. Overton	27/11/2017
Issue No =	Date
BM01/A001	27/11/2017

TECA BM 71 B14



www.tecmotors.co.uk