



## MOTOR DATA SHEET

**MOTOR PART CODE:**

**0.5541TCCB34**

**FRAME SIZE:**

**801-4**

**50Hz**

Output (kW)	0.55
Rotation Speed (rpm)	1420
Voltage	230
Full Load Current (A)	3.52
Full Load Torque (Nm)	3.70

Factory Reference	ML801-4
Tst/Tn (times)	2.5
Tmax/Tn	1.8
Noise (dB)	70
Moment of inertia	0.001380482
Type of feet	Removable feet
Rotation Direction	F / R
Cooling	IC411
Standard	IEC60034
IP Rating	IP55
Allowed Radial Load (N)	755
Bearing (DE)	6204 2RZ C3

Power Factor (cos)	0.95
Tmin/Tn	1.6
Ist/In (Times)	5.8
Net Weight (Kg)	9.6
Housing material	Aluminium
Insulation Class	F
Duty Cycle	S1
Paint	RAL 7024
Ambient Temperature	-20°C to +40°
Starting Method	DOL
Allowed Axial Load (N)	629
Bearing (NDE)	6204 2RZ C3

*Motors designed and manufactured in accordance with:*

**IEC 60034**  
**IEC 60038**  
**IEC 60072**  
**2014/30/EU (EMC)**  
**2014/35/EU (LVD)**  
**2011/65/EU (RoHS 2)**

[www.tecmotors.co.uk](http://www.tecmotors.co.uk)

TEC Electric Motors Ltd. reserves the right to amend or change motor designs or data sheet information

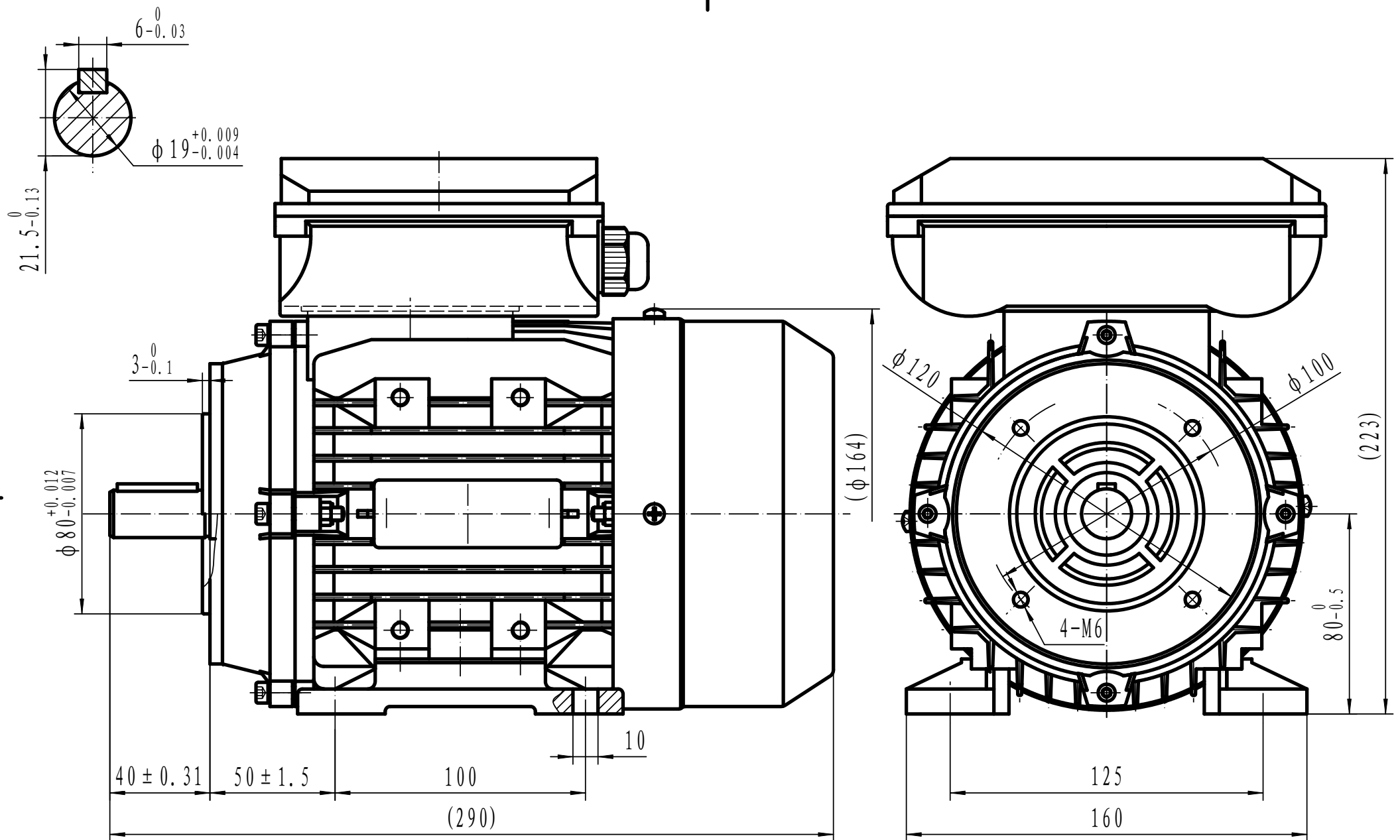

Drawn By	Date
A442313	27/11/2017
Approved by	Date
L. Overton	27/11/2017
Issue No =	Date
A401/001/18	27/11/2017

**TCC 80 B34**

  
[www.tecmotors.co.uk](http://www.tecmotors.co.uk)