



MOTOR DATA SHEET

MOTOR PART CODE:

0.5561TCCB35

FRAME SIZE:

802-6

50Hz

Output (kW)	0.55
Rotation Speed (rpm)	935
Voltage	230
Full Load Current (A)	3.47
Full Load Torque (Nm)	5.62

Factory Reference	ML802-6
Tst/Tn (times)	2.2
Tmax/Tn	1.45
Noise (dB)	70
Moment of inertia	0.002366145
Type of feet	Removable feet
Rotation Direction	F / R
Cooling	IC411
Standard	IEC60034
IP Rating	IP55
Allowed Radial Load (N)	864
Bearing (DE)	6204 2RS C3

Power Factor (cos)	0.97
Tmin/Tn	1.2
Ist/In (Times)	5.4
Net Weight (Kg)	10.8
Housing material	Aluminium
Insulation Class	F
Duty Cycle	S1
Paint	RAL 7024
Ambient Temperature	-20°C to +40°
Starting Method	DOL
Allowed Axial Load (N)	752
Bearing (NDE)	6204 2RS C3

Motors designed and manufactured in accordance with:

IEC 60034
IEC 60038
IEC 60072
2014/30/EU (EMC)
2014/35/EU (LVD)
2011/65/EU (RoHS 2)

www.tecmotors.co.uk

TEC Electric Motors Ltd. reserves the right to amend or change motor designs or data sheet information

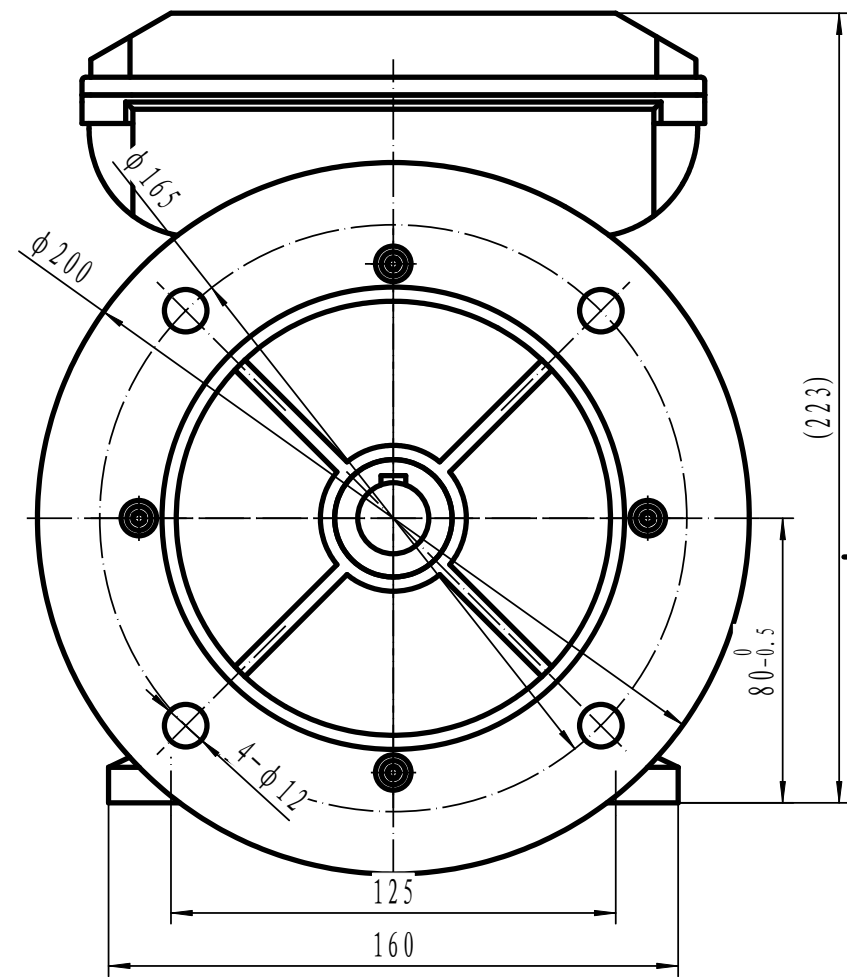
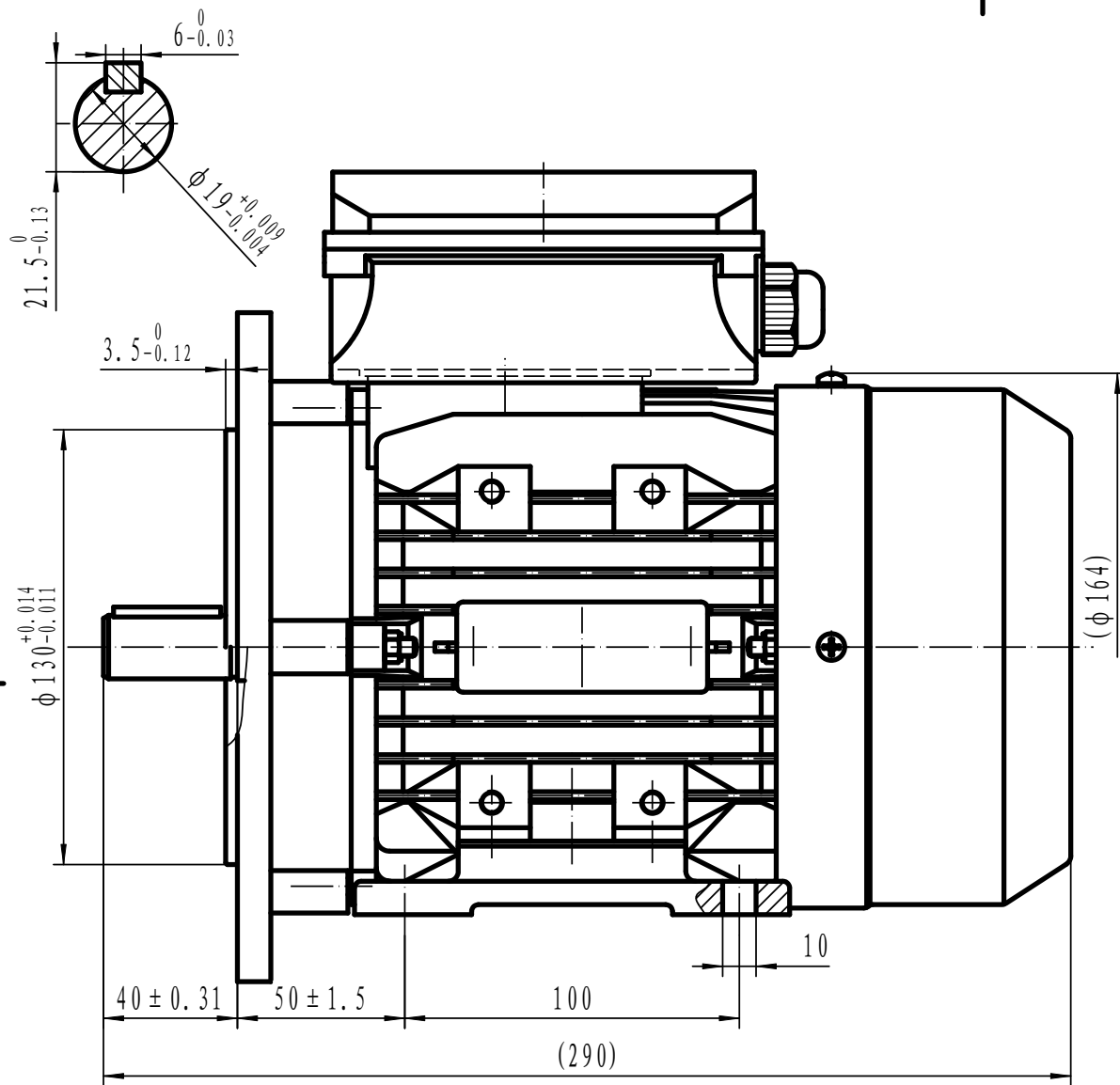

Drawn By	Date
A442313	27/11/2017
Approved by	Date
L. Overton	27/11/2017
Issue No =	Date
A401/001/18	27/11/2017

TCC 80 B35



www.tecmotors.co.uk