



MOTOR DATA SHEET

MOTOR PART CODE:

0.7521TPCB14B

FRAME SIZE:

801-2

50Hz

Output (kW)	0.75
Rotation Speed (rpm)	2760
Voltage	230
Full Load Current (A)	4.87
Full Load Torque (Nm)	2.60

Factory Reference	MYT801-2
Tst/Tn (times)	0.7
Tmax/Tn	1.8
Noise (dB)	75
Moment of inertia	0.001007097
Type of feet	Not Fitted
Rotation Direction	F / R
Cooling	IC411
Standard	IEC60034
IP Rating	IP55
Allowed Radial Load (N)	599
Bearing (DE)	6204 2RZ C3

Power Factor (cos)	0.97
Tmin/Tn	0.75
Ist/In (Times)	3.7
Net Weight (Kg)	10.25
Housing material	Aluminum
Insulation Class	F
Duty Cycle	S1
Paint	RAL 7024
Ambient Temperature	-20°C to +40°
Starting Method	DOL
Allowed Axial Load (N)	465
Bearing (NDE)	6204 2RZ C3

Motors designed and manufactured in accordance with:

IEC 60034
IEC 60038
IEC 60072
2014/30/EU (EMC)
2014/35/EU (LVD)
2011/65/EU (RoHS 2)

www.tecmotors.co.uk

TEC Electric Motors Ltd. reserves the right to amend or change motor designs or data sheet information

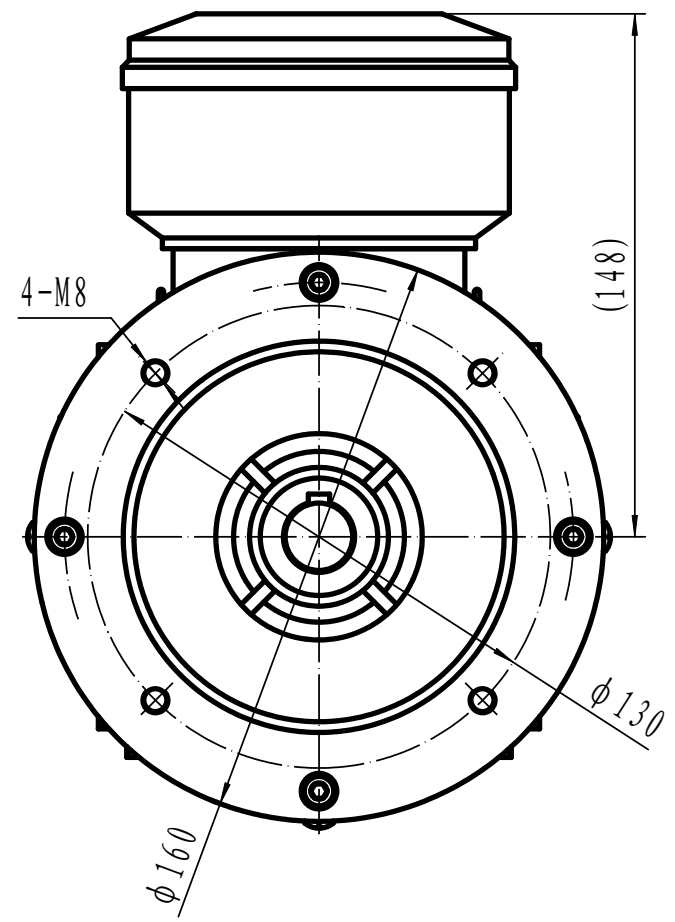
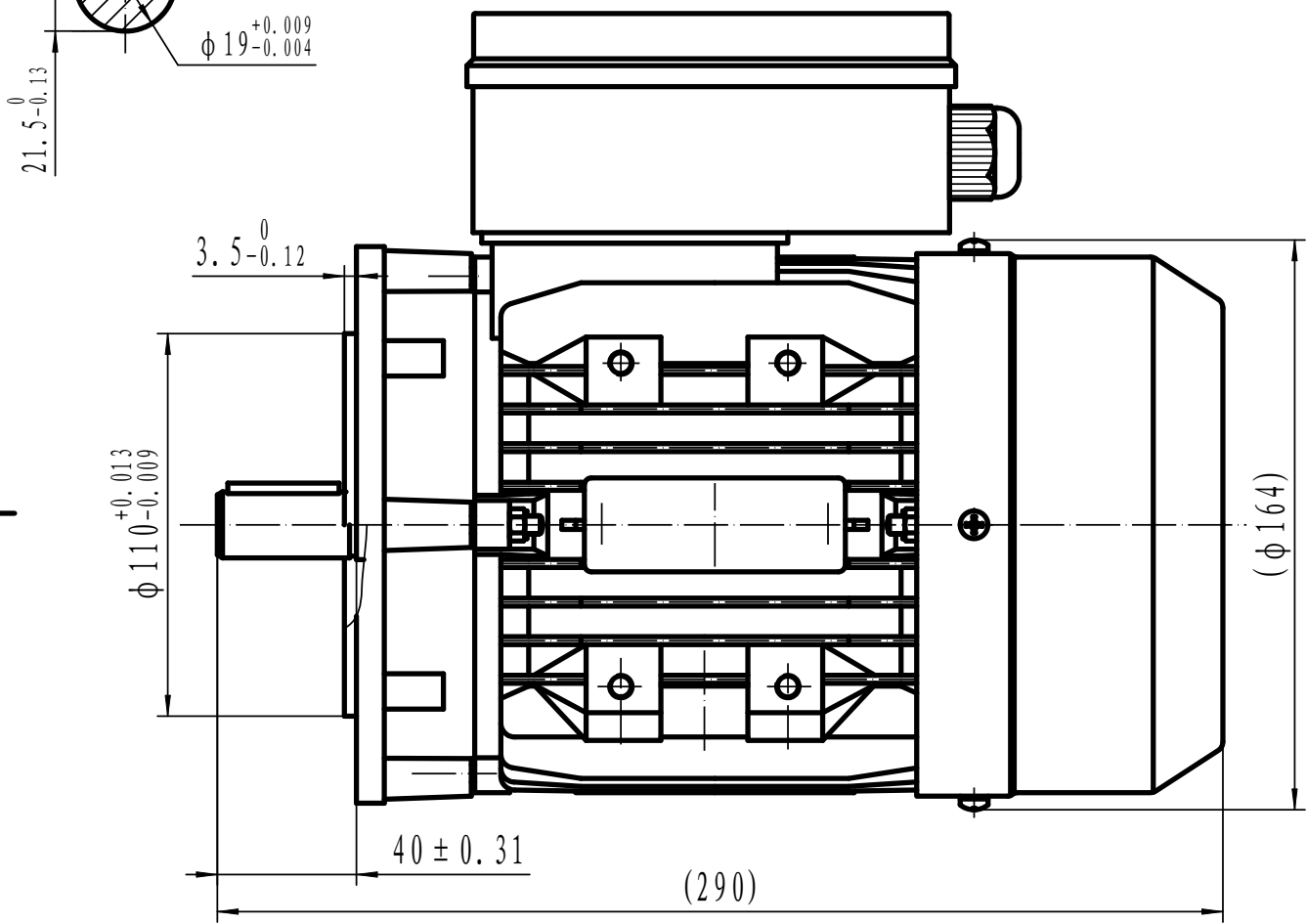
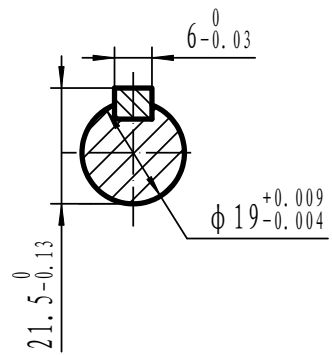

Drawn By	Date
A442313	27/11/2017
Approved by	Date
L. Overton	27/11/2017
Issue No =	Date
TPC01/A001	27/11/2017

TPC 80 B14B



www.tecmotors.co.uk