



MOTOR DATA SHEET

MOTOR PART CODE:

0.7541TPCB5

FRAME SIZE:

802-4

50Hz

Output (kW)	0.75
Rotation Speed (rpm)	1355
Voltage	230
Full Load Current (A)	4.82
Full Load Torque (Nm)	5.29

Factory Reference	MYT802-4
Tst/Tn (times)	0.67
Tmax/Tn	1.65
Noise (dB)	73
Moment of inertia	0.002393139
Type of feet	Not Fitted
Rotation Direction	F / R
Cooling	IC411
Standard	IEC60034
IP Rating	IP55
Allowed Radial Load (N)	755
Bearing (DE)	6204 2RZ C3

Power Factor (cos)	0.98
Tmin/Tn	0.65
Ist/In (Times)	3.4
Net Weight (Kg)	11.4
Housing material	Aluminum
Insulation Class	F
Duty Cycle	S1
Paint	RAL 7024
Ambient Temperature	-20°C to +40°
Starting Method	DOL
Allowed Axial Load (N)	629
Bearing (NDE)	6204 2RZ C3

Motors designed and manufactured in accordance with:

IEC 60034
IEC 60038
IEC 60072
2014/30/EU (EMC)
2014/35/EU (LVD)
2011/65/EU (RoHS 2)

www.tecmotors.co.uk

TEC Electric Motors Ltd. reserves the right to amend or change motor designs or data sheet information

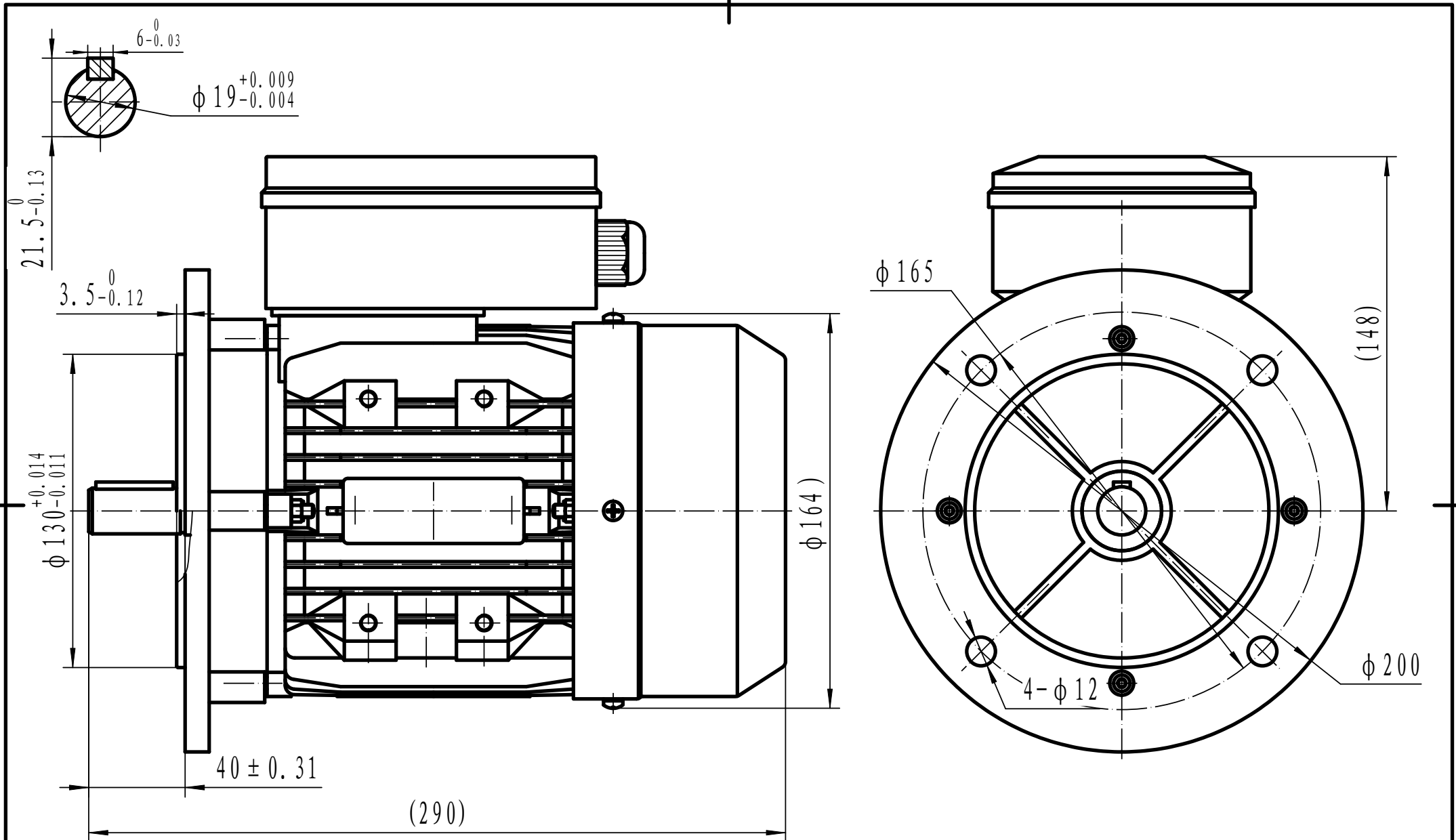

Drawn By	Date
A442313	27/11/2017
Approved by	Date
L. Overton	27/11/2017
Issue No =	Date
TPC01/A001	27/11/2017

TPC 80 B5



www.tecmotors.co.uk