



MOTOR DATA SHEET

MOTOR PART CODE:

0.7543TECAB34-IE3

FRAME SIZE:

802-4

	50Hz
Output (kW)	0.75
Rotation Speed (rpm)	1440
Voltage	230/400
Full Load Current (A)	3.29 1.9
Full Load Torque (Nm)	4.973958333

	60Hz
Output (kW)	0.9
Rotation Speed (rpm)	1728
Voltage	276 480
Full Load Current (A)	3.29 1.9
Full Load Torque (Nm)	4.14

Efficiency Data

100%	75%	50%
82.5	82.5	80.1

Factory Reference	T3A 802-4
Tst/Tn (times)	3.1
Tmax/Tn	3.1
Noise (dB)	58
Moment of inertia	0.002284565
Type of feet	Removable feet
Protection	IP55
Rotation Direction	F / R
Cable Glands	1 - M20 × 1.5
Paint Colour	RAL 7024
Efficiency	IE3
Bearing (DE)	6204 2RS C3

Power Factor (cos)	0.69
Tmin/Tn	2.5
Ist/In (Times)	6.3
Net Weight (Kg)	11.7
Housing material	Aluminum
Insulation Class	F
Thermal Protection	PTC 130°C
Duty Cycle	S1
Cooling	IC 411
Ambient Temperature	-20°C to +40°C
Bearing Brand	NSK
Bearing (NDE)	6204 2RS C3

Motors designed and manufactured in accordance with:

**IEC 60034
IEC 60038
IEC 60072
2014/30/EU (EMC)
2014/35/EU (LVD)
2011/65/EU (RoHS 2)**

www.tecmotors.co.uk

TEC Electric Motors Ltd. reserves the right to amend or change motor designs or data sheet information

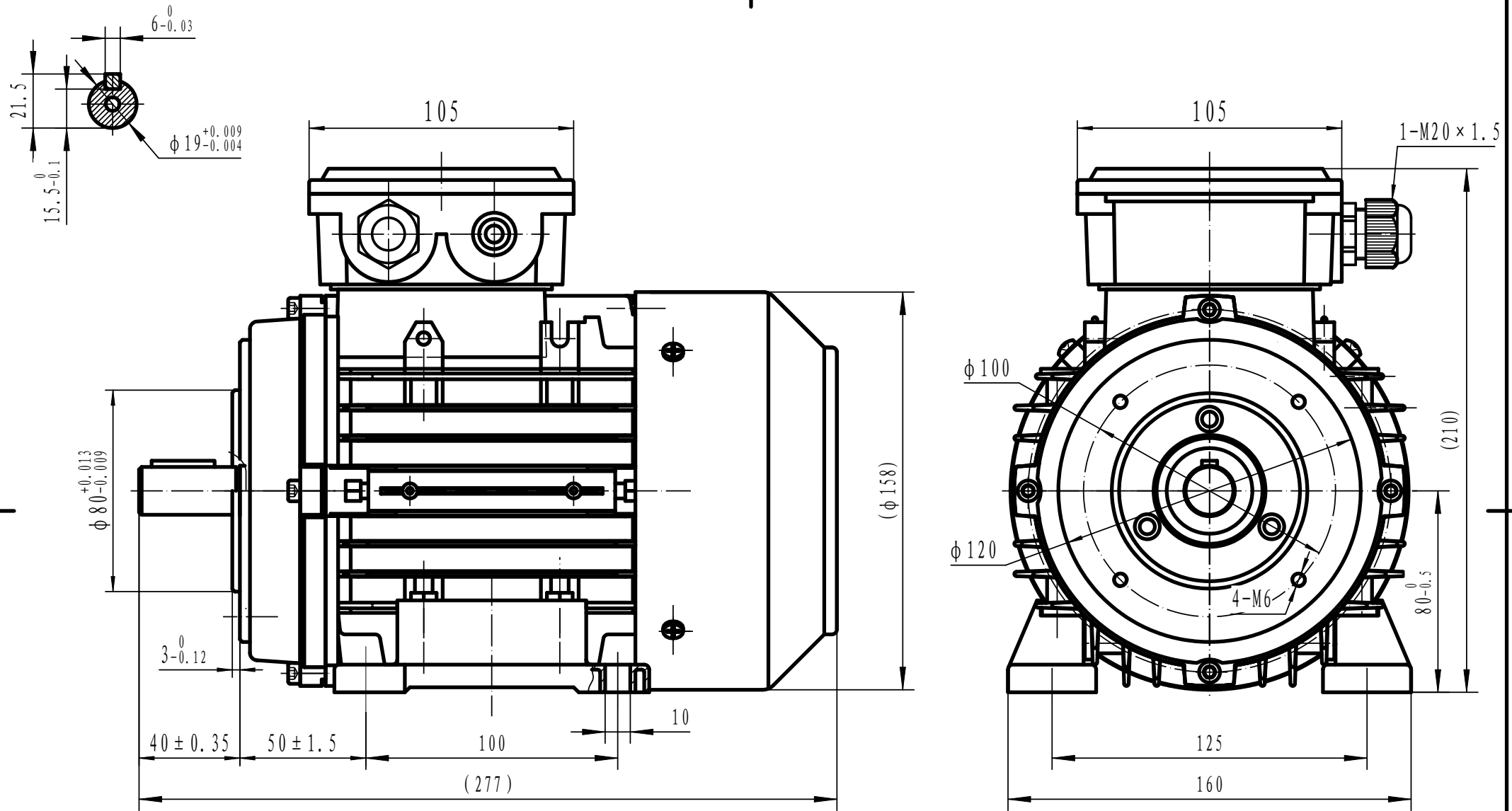

Drawn By	Date	TA80B34
TECHTOP	27/11/2017	
Approved by	Date	 www.tecmotors.co.uk
L. Overton	27/11/2017	
Issue No =	Date	
001/A	27/11/2017	