



# MOTOR DATA SHEET

**MOTOR PART CODE:**

**1.123TECCB3-IE3**

**FRAME SIZE:**

**802-2**

	50Hz
Output (kW)	1.1
Rotation Speed (rpm)	2880
Voltage	230/400
Full Load Current (A)	4.16   2.4
Full Load Torque (Nm)	3.65

	60Hz
Output (kW)	1.32
Rotation Speed (rpm)	3456
Voltage	276   480
Full Load Current (A)	4.16   2.4
Full Load Torque (Nm)	3.04

## Efficiency Data

100%	75%	50%
82.7	83.5	81.6

Factory Reference	T3C 802-2
Tst/Tn (times)	2.5
Tmax/Tn	2.8
Noise (dB)	67
Moment of inertia	0.00128
Type of feet	Removable feet
Protection	IP55
Rotation Direction	F / R
Cable Glands	1 - M20× 1.5
Paint Colour	RAL 7024
Efficiency	IE3
Bearing (DE)	6204 2RS C3

Power Factor (cos)	0.8
Tmin/Tn	1.8
Ist/In (Times)	8
Net Weight (Kg)	17.1
Housing material	Cast Iron
Insulation Class	F
Thermal Protection	PTC 140°C
Duty Cycle	S1
Cooling	IC411
Ambient Temperature	-20°C to +40°C
Bearing Brand	NSK
Bearing (NDE)	6204 2RS C3

*Motors designed and manufactured in accordance with:*

**IEC 60034  
IEC 60038  
IEC 60072  
2014/30/EU (EMC)  
2014/35/EU (LVD)  
2011/65/EU (RoHS 2)**

[www.tecmotors.co.uk](http://www.tecmotors.co.uk)

TEC Electric Motors Ltd. reserves the right to amend or change motor designs or data sheet information

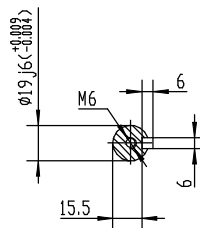
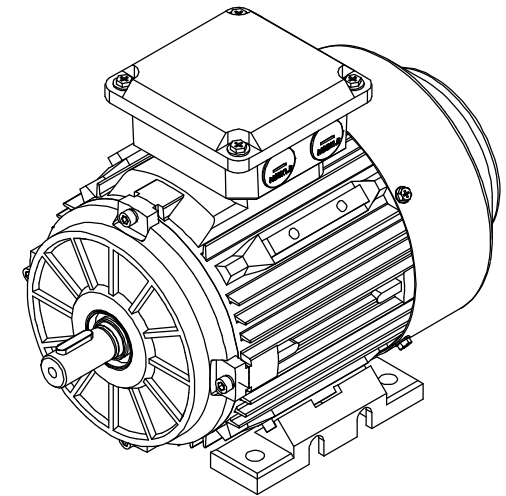
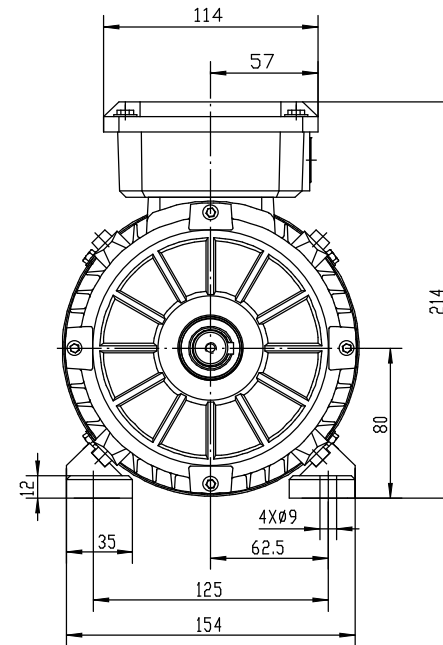
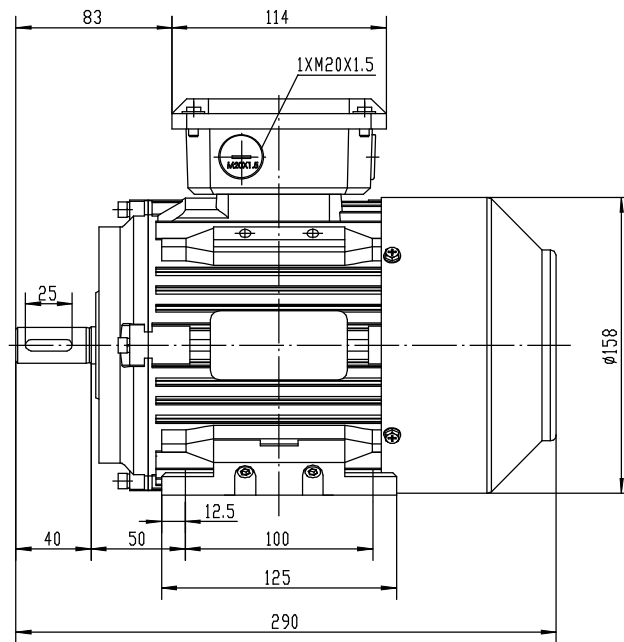

Drawn By	Date
A442313	27/11/2017
Approved by	Date
L. Overton	27/11/2017
Issue No =	Date
BM01/A001	27/11/2017

**TC 80 B3**

