



# MOTOR DATA SHEET

**MOTOR PART CODE:**

**1.163TECCB5-IE2**

**FRAME SIZE:**

**90L-6**

	50Hz
Output (kW)	1.1
Rotation Speed (rpm)	935
Voltage	230/400
Full Load Current (A)	5.18/2.99
Full Load Torque (Nm)	11.24

	60Hz
Output (kW)	1.32
Rotation Speed (rpm)	1122
Voltage	276/480
Full Load Current (A)	5.18/2.99
Full Load Torque (Nm)	9.37

## Efficiency Data

100%	75%	50%
78.1	78.6	77.6

Factory Reference	T2C 90L-6
Tst/Tn (times)	2
Tmax/Tn	2.2
Noise (dB)	57
Moment of inertia	0.00536
Type of feet	Not fitted
Protection	IP55
Rotation Direction	F / R
Cable Glands	1 - M20× 1.5
Paint Colour	RAL 7024
Efficiency	IE2
Bearing (DE)	6205 2RS C3

Power Factor (cos)	0.68
Tmin/Tn	1.8
Ist/In (Times)	5
Net Weight (Kg)	23.5
Housing material	Cast Iron
Insulation Class	F
Thermal Protection	PTC 140°C
Duty Cycle	S1
Cooling	IC 411
Ambient Temperature	-20°C to +40°C
Bearing Brand	NSK
Bearing (NDE)	6205 2RS C3

*Motors designed and manufactured in accordance with:*

**IEC 60034  
IEC 60038  
IEC 60072  
2014/30/EU (EMC)  
2014/35/EU (LVD)  
2011/65/EU (RoHS 2)**

[www.tecmotors.co.uk](http://www.tecmotors.co.uk)

TEC Electric Motors Ltd. reserves the right to amend or change motor designs or data sheet information

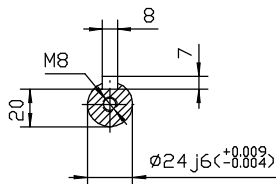
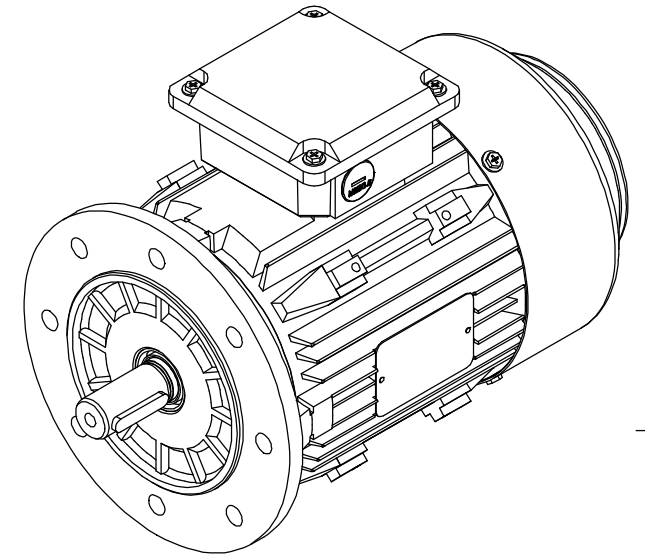
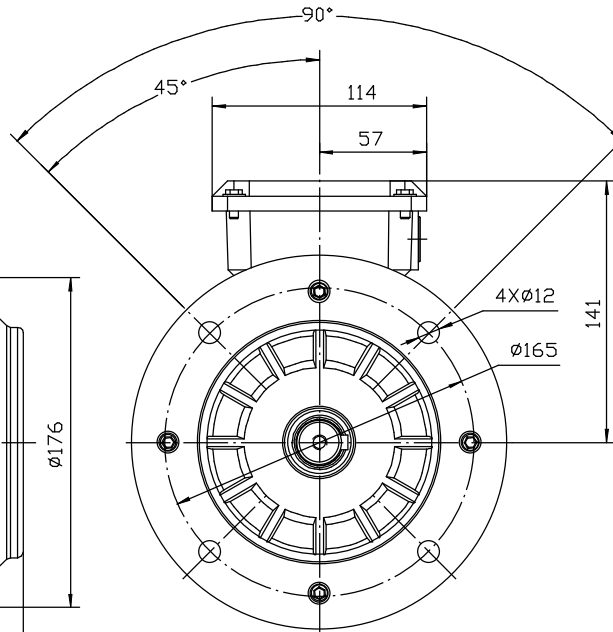
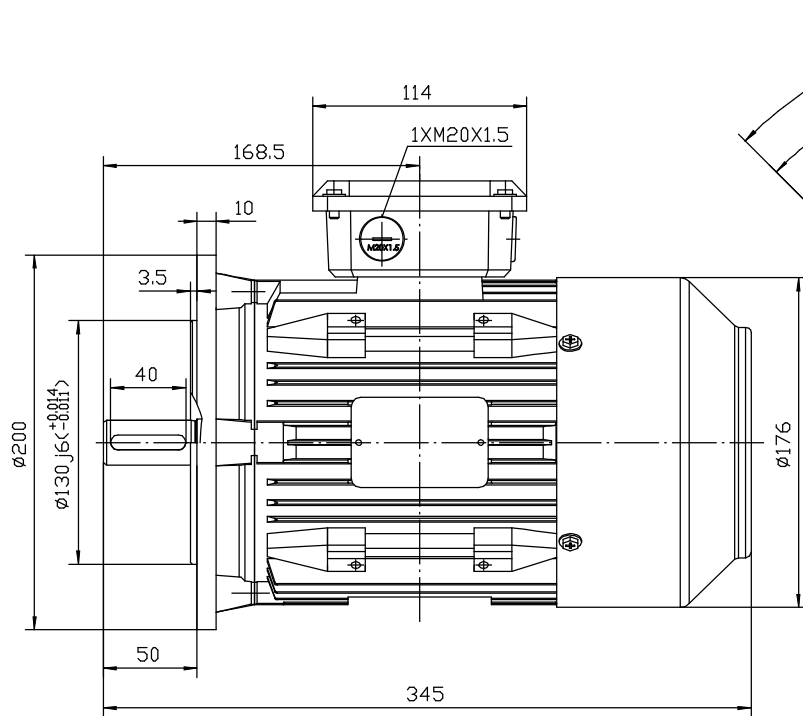

Drawn By	Date
A442313	27/11/2017
Approved by	Date
L. Overton	27/11/2017
Issue No =	Date
BM01/A001	27/11/2017

**TC 90L B5**

