



BRAKE MOTOR DATA SHEET

MOTOR PART CODE:

1.523TECAB34-BM

FRAME SIZE:

90S-2

	50Hz
Output (kW)	1.5
Rotation Speed (rpm)	2860
Voltage	230/400
Full Load Current (A)	5.56 3.21
Full Load Torque (Nm)	5.01

	60Hz
Output (kW)	1.8
Rotation Speed (rpm)	3432
Voltage	276 480
Full Load Current (A)	5.56 3.21
Full Load Torque (Nm)	4.18

Efficiency Data

100%	75%	50%
81.3	81.2	78.8

Factory Reference	MSB90S-2
Tst/Tn (times)	4.5
Tmax/Tn	3.5
Noise (dB)	72
Moment of inertia	0.00143
Type of feet	Removable feet
Protection	IP55
Rotation Direction	F / R
Cable Glands	1 - M20 × 1.5
Paint Colour	RAL 7024
Brake Torque (Nm)	11
Brake Voltage	205v DC
Recitifer	Full wave

Power Factor (cos)	0.83
Tmin/Tn	2.7
Ist/In (Times)	8.2
Net Weight (Kg)	13.2
Housing material	Aluminum
Insulation Class	F
Thermal Protection	PTC 130°C
Duty Cycle	S1
Cooling	IC411
Ambient Temperature	-20°C to + 40°C
Bearing Brand	NSK
Bearing (DE)	6205 2RS C3
Bearing (NDE)	6205 2RS C3

Motors designed and manufactured in accordance with:

IEC 60034
IEC 60038
IEC 60072
2014/30/EU (EMC)
2014/35/EU (LVD)
2011/65/EU (RoHS 2)

www.tecmotors.co.uk

TEC Electric Motors Ltd. reserves the right to amend or change motor designs or data sheet information

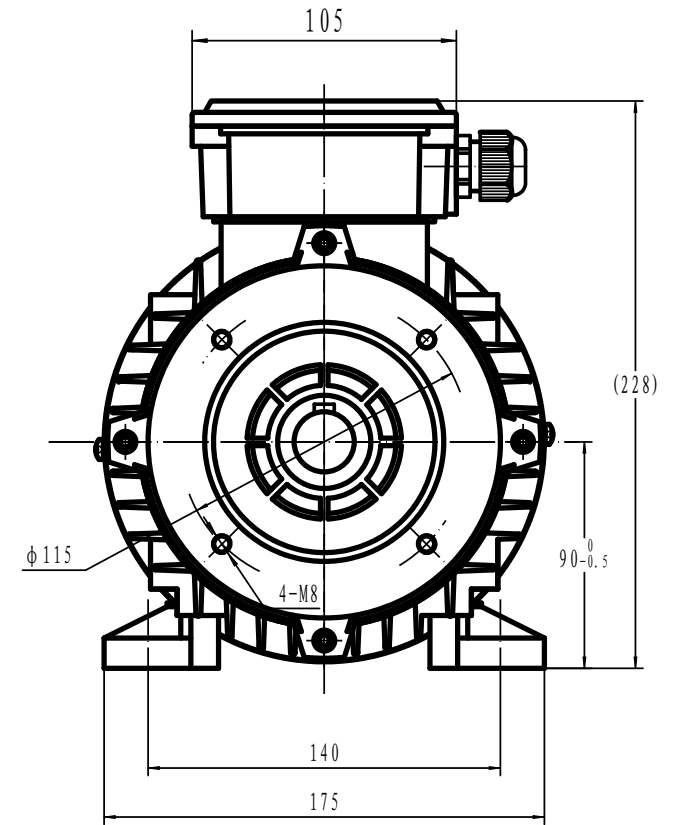
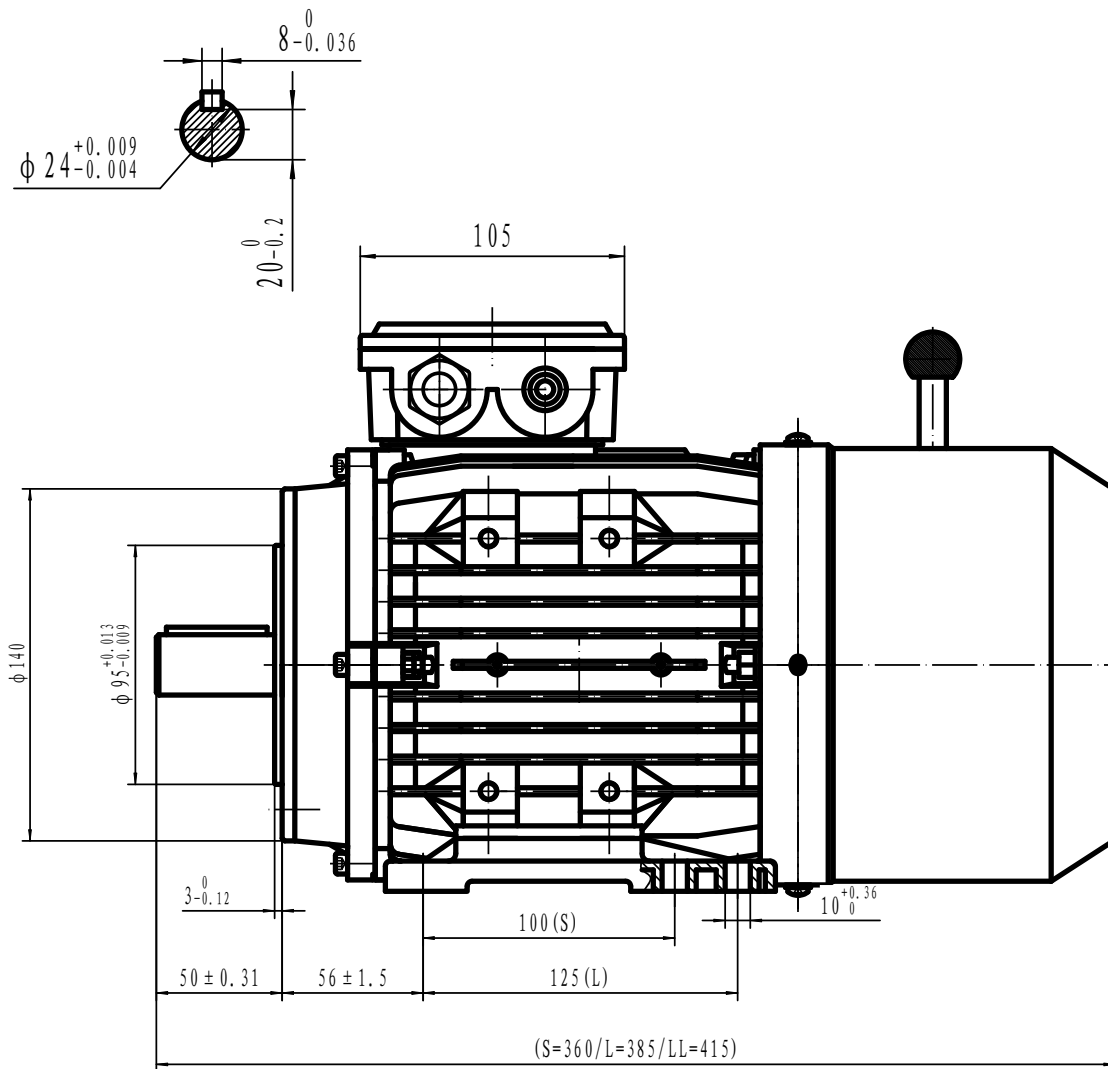

										上海特波电机有限公司			
										MSB90 B34外形图			
标记	处数	分区	更改文件号	签名	年、月、日					阶段标记	重量	比例	
设计			标准化									1:1.5	
审核													
工艺						批准				共	张	第	张