



MOTOR DATA SHEET

MOTOR PART CODE:

1.523TECCB35-IE2

FRAME SIZE:

90S-2

	50Hz
Output (kW)	1.5
Rotation Speed (rpm)	2880
Voltage	230/400
Full Load Current (A)	5.63/3.25
Full Load Torque (Nm)	4.97

	60Hz
Output (kW)	1.8
Rotation Speed (rpm)	3456
Voltage	276/480
Full Load Current (A)	5.63/3.25
Full Load Torque (Nm)	4.14

Efficiency Data

100%	75%	50%
81.3	81.9	81

Factory Reference	T2C 90S-2
Tst/Tn (times)	2.5
Tmax/Tn	2.6
Noise (dB)	72
Moment of inertia	0.00184
Type of feet	Removable feet
Protection	IP55
Rotation Direction	F / R
Cable Glands	1 - M20× 1.5
Paint Colour	RAL 7024
Efficiency	IE2
Bearing (DE)	6205 2RS C3

Power Factor (cos)	0.82
Tmin/Tn	1.8
Ist/In (Times)	7
Net Weight (Kg)	18.5
Housing material	Cast Iron
Insulation Class	F
Thermal Protection	PTC 140°C
Duty Cycle	S1
Cooling	IC 411
Ambient Temperature	-20°C to +40°C
Bearing Brand	NSK
Bearing (NDE)	6205 2RS C3

Motors designed and manufactured in accordance with:

**IEC 60034
IEC 60038
IEC 60072
2014/30/EU (EMC)
2014/35/EU (LVD)
2011/65/EU (RoHS 2)**

www.tecmotors.co.uk

TEC Electric Motors Ltd. reserves the right to amend or change motor designs or data sheet information

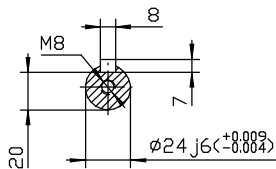
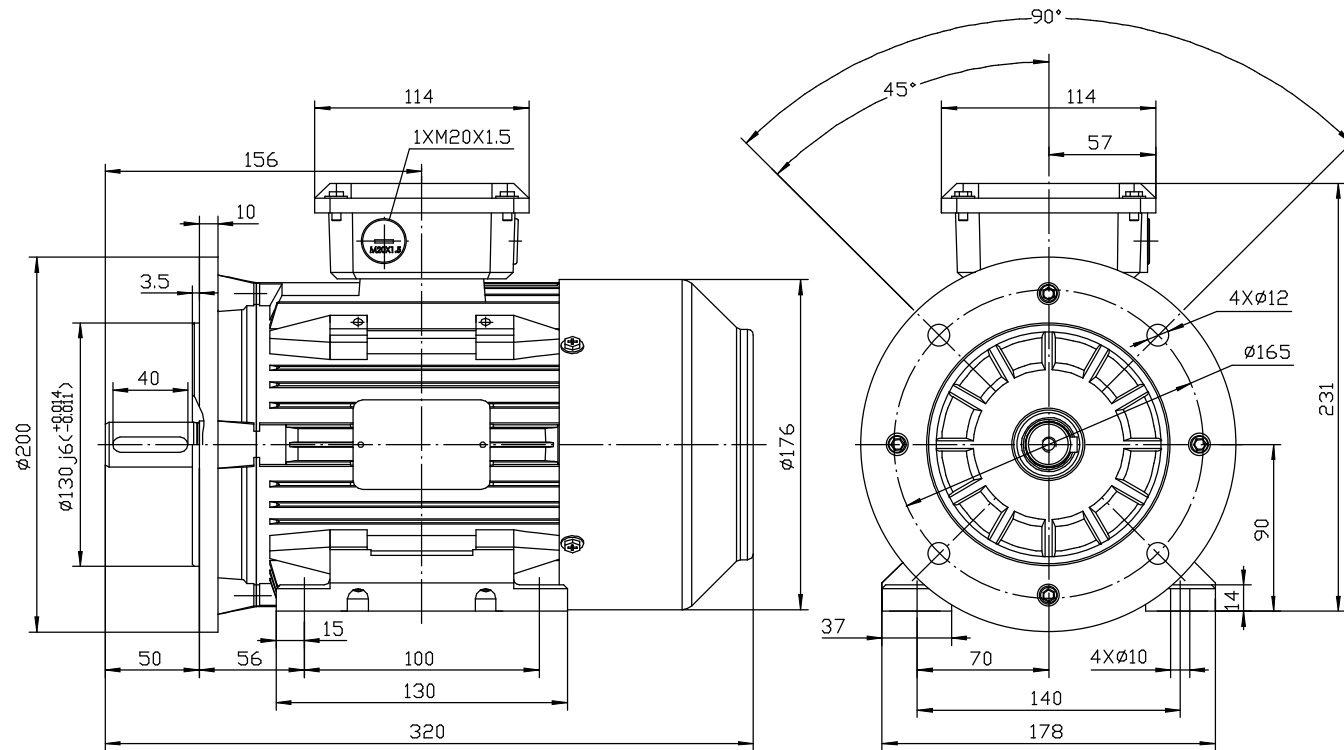

Drawn By	Date
A442313	27/11/2017
Approved by	Date
L. Overton	27/11/2017
Issue No =	Date
BM01/A001	27/11/2017

TC 90S B35

