



MOTOR DATA SHEET

MOTOR PART CODE:

1.543TECCB5-IE2

FRAME SIZE:

90L-4

	50Hz
Output (kW)	1.5
Rotation Speed (rpm)	1430
Voltage	230/400
Full Load Current (A)	6.12/3.53
Full Load Torque (Nm)	10.02

	60Hz
Output (kW)	1.8
Rotation Speed (rpm)	1716
Voltage	276/480
Full Load Current (A)	6.12/3.53
Full Load Torque (Nm)	8.35

Efficiency Data

100%	75%	50%
82.8	83.4	80.4

Factory Reference	T2C 90L-4
Tst/Tn (times)	2.5
Tmax/Tn	2.6
Noise (dB)	61
Moment of inertia	0.00411
Type of feet	Not fitted
Protection	IP55
Rotation Direction	F / R
Cable Glands	1 - M20× 1.5
Paint Colour	RAL 7024
Efficiency	IE2
Bearing (DE)	6205 2RS C3

Power Factor (cos)	0.74
Tmin/Tn	2
Ist/In (Times)	6.5
Net Weight (Kg)	24
Housing material	Cast Iron
Insulation Class	F
Thermal Protection	PTC 140°C
Duty Cycle	S1
Cooling	IC 411
Ambient Temperature	-20°C to +40°C
Bearing Brand	NSK
Bearing (NDE)	6205 2RS C3

Motors designed and manufactured in accordance with:

**IEC 60034
IEC 60038
IEC 60072
2014/30/EU (EMC)
2014/35/EU (LVD)
2011/65/EU (RoHS 2)**

www.tecmotors.co.uk

TEC Electric Motors Ltd. reserves the right to amend or change motor designs or data sheet information

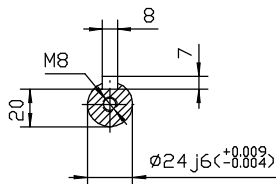
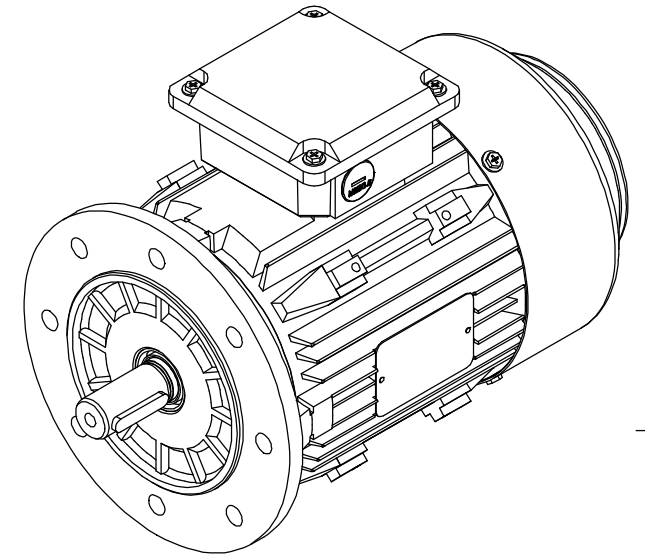
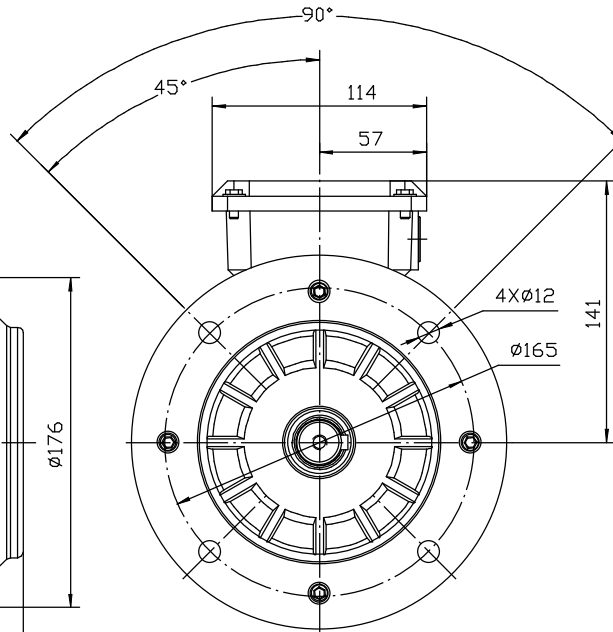
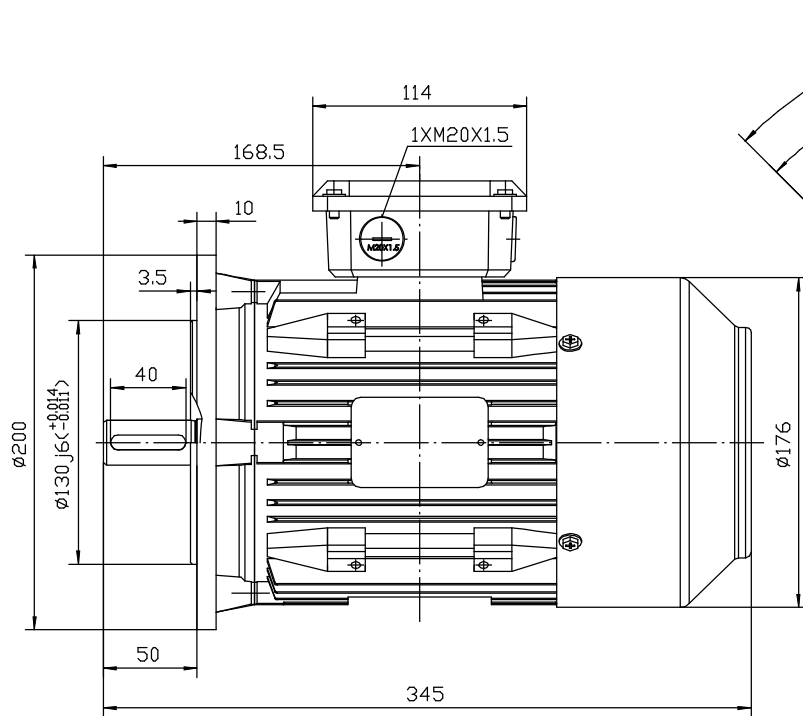

Drawn By	Date
A442313	27/11/2017
Approved by	Date
L. Overton	27/11/2017
Issue No =	Date
BM01/A001	27/11/2017

TC 90L B5

