



# MOTOR DATA SHEET

**MOTOR PART CODE:**

**1.563TECAB35-IE3**

**FRAME SIZE:**

**100L-6**

	50Hz
Output (kW)	1.5
Rotation Speed (rpm)	955
Voltage	230/400
Full Load Current (A)	6.49   3.75
Full Load Torque (Nm)	15

	60Hz
Output (kW)	1.8
Rotation Speed (rpm)	1146
Voltage	276   480
Full Load Current (A)	6.49   3.75
Full Load Torque (Nm)	12.50

## Efficiency Data

100%	75%	50%
82.5	83	81.8

Factory Reference	T3A 100L-6
Tst/Tn (times)	2.4
Tmax/Tn	2.9
Noise (dB)	61
Moment of inertia	0.009137291
Type of feet	Removable feet
Protection	IP55
Rotation Direction	F / R
Cable Glands	2 - M20 × 1.5
Paint Colour	RAL 7024
Efficiency	IE3
Bearing (DE)	6206 2RS C3

Power Factor (cos)	0.7
Tmin/Tn	2.2
Ist/In (Times)	5.5
Net Weight (Kg)	22.1
Housing material	Aluminum
Insulation Class	F
Thermal Protection	PTC 130°C
Duty Cycle	S1
Cooling	IC 411
Ambient Temperature	-20°C to +40°C
Bearing Brand	NSK
Bearing (NDE)	6206 2RS C3

*Motors designed and manufactured in accordance with:*

**IEC 60034  
IEC 60038  
IEC 60072  
2014/30/EU (EMC)  
2014/35/EU (LVD)  
2011/65/EU (RoHS 2)**

[www.tecmotors.co.uk](http://www.tecmotors.co.uk)

TEC Electric Motors Ltd. reserves the right to amend or change motor designs or data sheet information

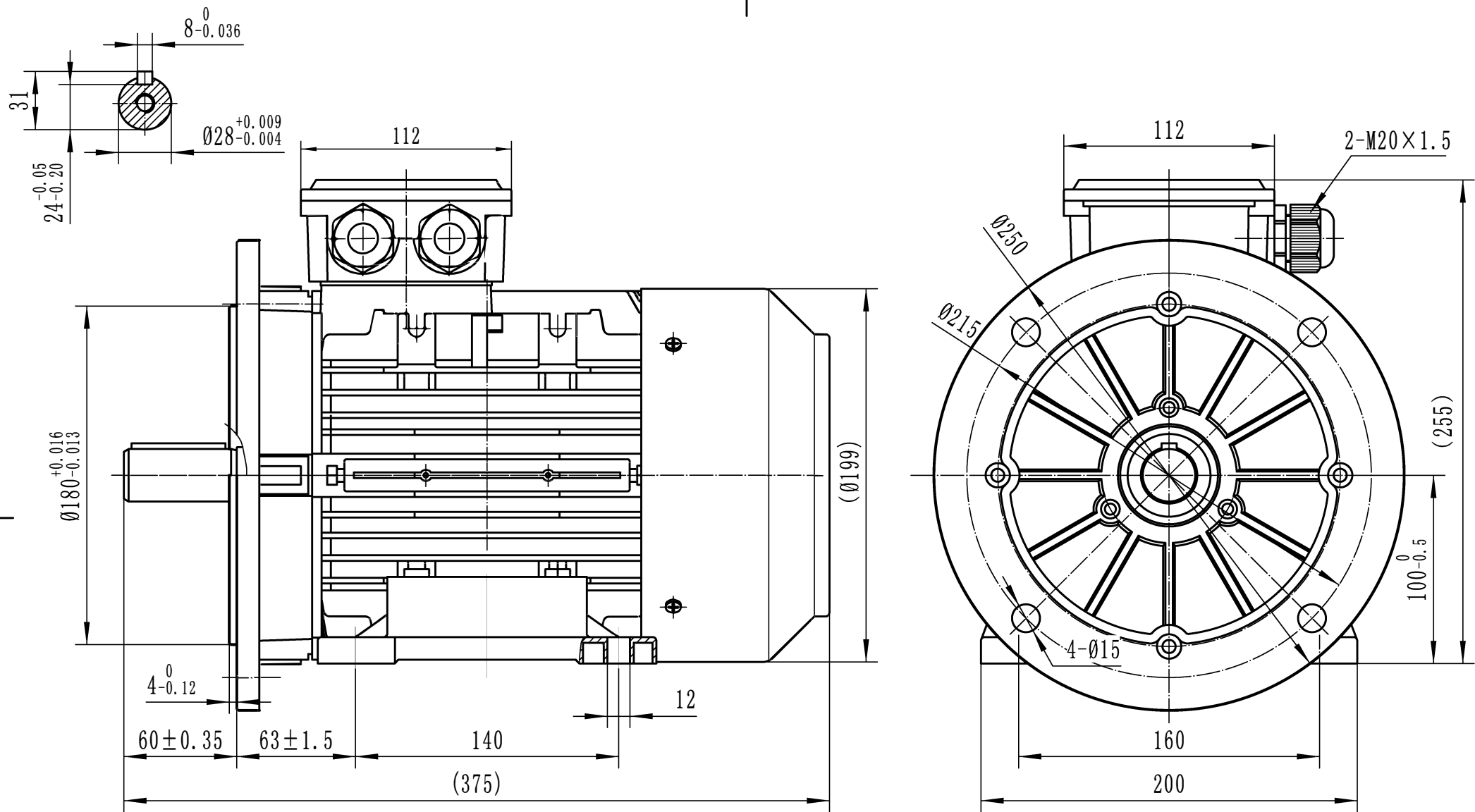

Drawn By	Date
TECHTOP	27/11/2017
Approved by	Date
L. Overton	27/11/2017
Issue No =	Date
001/A	27/11/2017

**TA100B35**

