



MOTOR DATA SHEET

MOTOR PART CODE:

9.243TECAB5-IE2

FRAME SIZE:

132M2-4

	50Hz
Output (kW)	9.2
Rotation Speed (rpm)	1460
Voltage	400/690
Full Load Current (A)	17.51 10.11
Full Load Torque (Nm)	60.17808219

	60Hz
Output (kW)	11.04
Rotation Speed (rpm)	1752
Voltage	480 828
Full Load Current (A)	17.51 10.11
Full Load Torque (Nm)	50.15

Efficiency Data

100%	75%	50%
89.2	90.1	89.9

Factory Reference	T2A 132M2-4
Tst/Tn (times)	2.9
Tmax/Tn	3.2
Noise (dB)	74
Moment of inertia	0.04617758
Type of feet	No Feet Fitted
Protection	IP55
Rotation Direction	F / R
Cable Glands	2 - M25× 1.5
Paint Colour	RAL 7024
Efficiency	IE2
Bearing (DE)	6308 2RS C3

Power Factor (cos)	0.85
Tmin/Tn	1.7
Ist/In (Times)	8.7
Net Weight (Kg)	56.6
Housing material	Aluminum
Insulation Class	F
Thermal Protection	PTC 130°C
Duty Cycle	S1
Cooling	IC411
Ambient Temperature	-20°C to +40°
Bearing Brand	NSK
Bearing (NDE)	6208 2RS C3

Motors designed and manufactured in accordance with:

**IEC 60034
IEC 60038
IEC 60072
2014/30/EU (EMC)
2014/35/EU (LVD)
2011/65/EU (RoHS 2)**

www.tecmotors.co.uk

TEC Electric Motors Ltd. reserves the right to amend or change motor designs or data sheet information

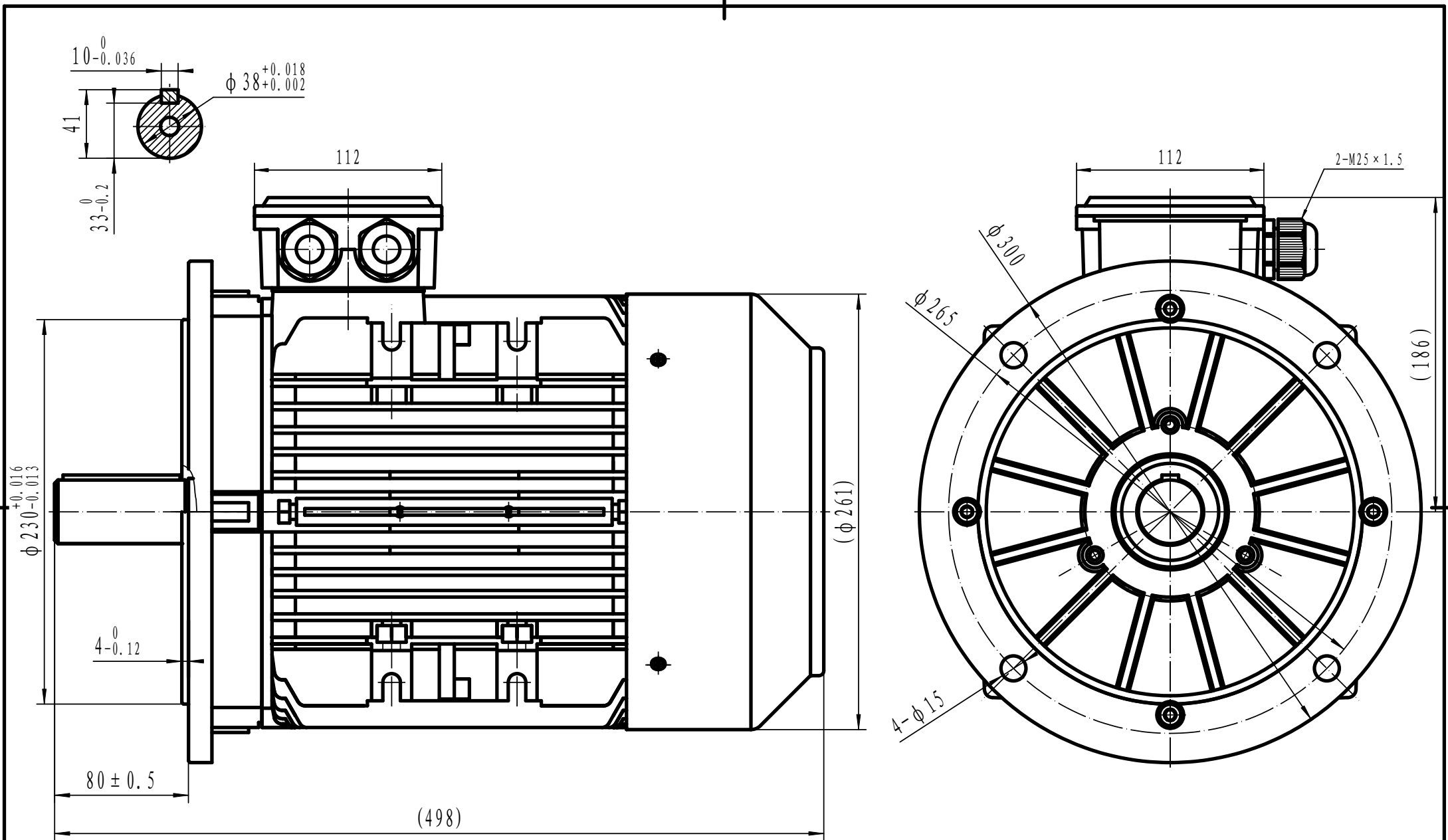

Drawn By	Date
TECHTOP	27/11/2017
Approved by	Date
L. Overton	27/11/2017
Issue No =	Date
001/A	27/11/2017

TA132MB5

www.tecmotors.co.uk