



3

Angular contact ball bearings



3 Angular contact ball bearings



Designs and variants	385	Designation system	404
Single row angular contact ball bearings	385	Product tables	
Basic design bearings	385	3.1 Single row angular contact ball bearings	406
Bearings for universal matching	385	3.2 Double row angular contact ball bearings	424
Bearings with 25° contact angle (AC series)	386	3.3 Capped double row angular contact ball bearings .	428
Double row angular contact ball bearings	386	3.4 Four-point contact ball bearings	430
Basic design bearings	386		
Bearings with a two-piece inner ring	386		
Four-point contact ball bearings	387		
Bearings with locating slots	387		
SKF Explorer bearings	387		
Capped bearings	388		
Greases for capped bearings	389		
Grease life for capped bearings	389		
Cages	390		
Bearing data	392		
(Dimension standards, tolerances, contact angle, internal clearance, preload, permissible misalignment)			
Loads	398		
(Minimum load, equivalent dynamic bearing load, equivalent static bearing load)			
Calculating the axial load for bearings mounted singly or paired in tandem	400		
Load carrying capacity of bearing pairs	400		
Temperature limits	402		
Permissible speed	402		
Design considerations	403		
Single row angular contact ball bearings	403	Other angular contact ball bearings	
Proper adjustment	403	Cam rollers	931
Axial loads in one direction	403	Bearings with Solid Oil	1023
Load ratio	403	NoWear coated bearings	1059
Four-point contact ball bearings	403	Super-precision bearings	→ skf.com/super-precision
Used as a thrust bearing	403	Hybrid bearings	→ skf.com/super-precision
Load ratio	403		

3 Angular contact ball bearings

3



More information

General bearing knowledge 17

Bearing selection process 59

Lubrication 109

Bearing interfaces 139

Seat tolerances for standard conditions 148

Selecting internal clearance or preload 182

Sealing, mounting and dismounting 193

Mounting instructions for individual bearings → skf.com/mount

Angular contact ball bearings have inner and outer ring raceways that are displaced relative to each other in the direction of the bearing axis. This means that these bearings are designed to accommodate combined loads, i.e. simultaneously acting radial and axial loads.

The axial load carrying capacity of angular contact ball bearings increases as the contact angle increases. The contact angle is defined as the angle between the line joining the points of contact of the ball and the raceways in the radial plane, along which the combined load is transmitted from one raceway to another, and a line perpendicular to the bearing axis (fig. 1).

The most commonly used designs are:

- single row angular contact ball bearings (fig. 2)
- double row angular contact ball bearings (fig. 3)
- four-point contact ball bearings (fig. 4)

In addition to the bearings presented in this catalogue, other angular contact ball bearings include:

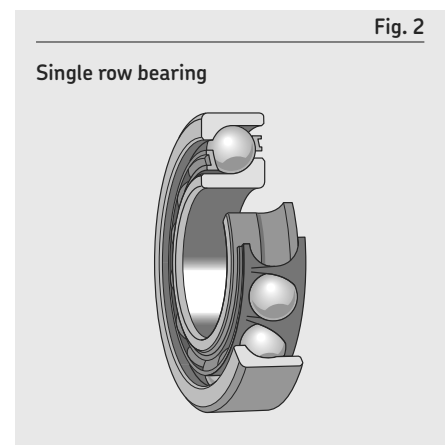
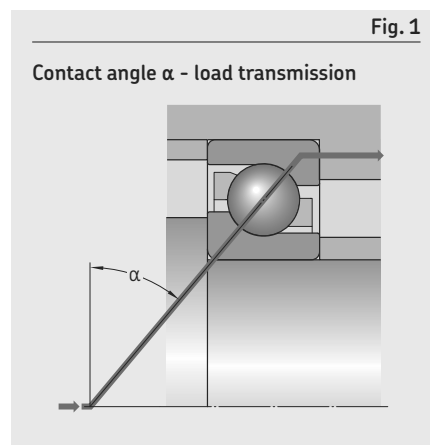
- **Super-precision angular contact ball bearings**

→ skf.com/super-precision

- **Fixed section angular contact ball bearings**

These bearings have very thin rings and a constant cross-sectional height within a particular series, irrespective of the bearing size. They are characterized by a low weight and high stiffness. SKF fixed section bearings have inch sizes and are available open or sealed in up to eight different cross-sectional heights. The designs include:

- single row angular contact ball bearings
- four-point contact ball bearings



- **Hub bearing units**

Hub bearing units (HBU) for the automotive industry are based on double row angular contact ball bearings. They have made an appreciable contribution to the achievement of more compact weight-saving designs, simplified assembly and enhanced reliability.

Detailed information about these products and variants for industrial applications can be supplied on request.

Bearing features

- **Accommodate combined loads**
 - Axial loads in one direction only for single row bearings
 - Axial loads in either direction for double row and four-point contact bearings
- **High load carrying capacity**
 - The lower shoulder enables a large number of balls to be incorporated in single row bearings, giving them their relatively high load carrying capacity.
 - Because of the second row of balls, a large number of balls are incorporated in double row bearings, giving them their high load carrying capacity.
 - A large number of balls are incorporated in four-point contact bearings, giving them their high load carrying capacity.
- **Good running properties**

High speeds, rapid accelerations and decelerations are possible.

Designs and variants

Single row angular contact ball bearings

SKF single row angular contact ball bearings (fig. 2) can accommodate axial loads in one direction only. This type of bearing is typically adjusted against a second bearing. Their bearing rings have an upper and a lower shoulder and are non-separable.

SKF standard assortment

- bearings in the 72 B(E) and 73 B(E) series with 40° contact angle
- some sizes in the 70 B series
- sealed bearings:
 - in series 72 B(E) ($15 \leq d \leq 55$ mm)
 - in series 73 B(E) ($12 \leq d \leq 50$ mm)
- bearings in the 72 AC series with 25° contact angle ($15 \leq d \leq 70$ mm)
- bearings in the 73 AC series with 25° contact angle ($17 \leq d \leq 70$ mm)
- some large size bearings with a flanged outer ring (skf.com/go/17000-3-1)
- SKF inch bearings (ALS and AMS series, skf.com/go/17000-3-1)

Basic design bearings

- are intended for adjusted arrangements where only one bearing is used at each bearing position and are not suitable for mounting immediately adjacent to each other
- have Normal tolerances on bearing width and standout of the rings
- have different performance capabilities compared with SKF Explorer bearings

Bearings for universal matching

- are available with 25° and 40° contact angles
- are intended to be used in sets
- have ring widths and standouts manufactured to tight tolerances
- can also be used in place of basic design bearings for arrangements with single bearings, as they typically have higher precision, and increased load carrying capacity and speed capability

When two bearings are mounted immediately adjacent to each other, a given internal clearance or preload or an even load distribution between the two bearings is obtained without the use of shims or similar devices.

Bearings for universal matching are identified by the following suffixes:

- CA, CB, CC or G for internal clearance
- GA, GB or GC for preload

When ordering, indicate the number of individual bearings required and not the number of sets.

Fig. 3

Double row bearing

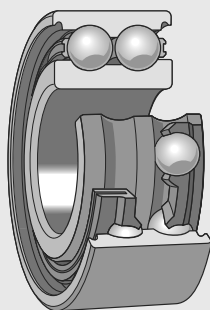
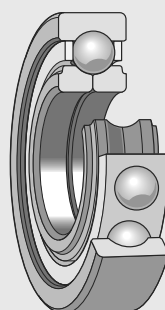


Fig. 4

Four-point contact bearing



3 Angular contact ball bearings

Paired mounting

Paired mounting can be done in three ways (fig. 5):

- **Tandem arrangement**

- is used where the load carrying capacity of a single bearing is inadequate
- shares the radial and axial loads equally
- has parallel load lines
- can accommodate axial loads in one direction only

If axial loads act in both directions, a third bearing, adjusted against the tandem pair, must be added.

- **Back-to-back arrangement**

- provides a relatively stiff bearing arrangement
- can accommodate tilting moments
- has load lines that diverge from the bearing axis
- can accommodate axial loads in both directions, but only by one bearing in each direction

- **Face-to-face arrangement**

- is less sensitive to misalignment but not as stiff as a back-to-back arrangement
- has load lines that converge towards the bearing axis
- can accommodate axial loads in both directions, but only by one bearing in each direction

Bearings with 25° contact angle (AC series)

- have a raceway geometry optimized for high speeds
- have reduced sensitivity to axial loading and misalignment, including the ability to accommodate two times higher impact loads before edge stresses can occur
- are equipped with an optimized machined brass cage as standard

Compared with bearings with 40° contact angle, benefits include:

- 20% higher limiting speeds
- higher radial load carrying capacity (by trading off lower axial load carrying capacity)
- increased robustness when used as the backup bearing in sets that are predominantly loaded in one direction

Double row angular contact ball bearings

The design of SKF double row angular contact ball bearings (fig. 3, page 385) corresponds to two single row angular contact ball bearings arranged back-to-back, but takes up less axial space. They can accommodate radial loads, axial loads in either direction and tilting moments. Double row angular contact ball bearings provide stiff bearing arrangements.

SKF standard assortment

- bearings in the 32 A and 33 A series
- bearings with a two-piece inner ring
- capped bearings
- open bearings (that are also available capped) that may have recesses in the ring side faces

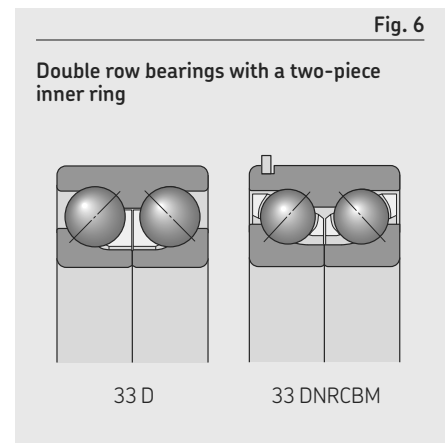
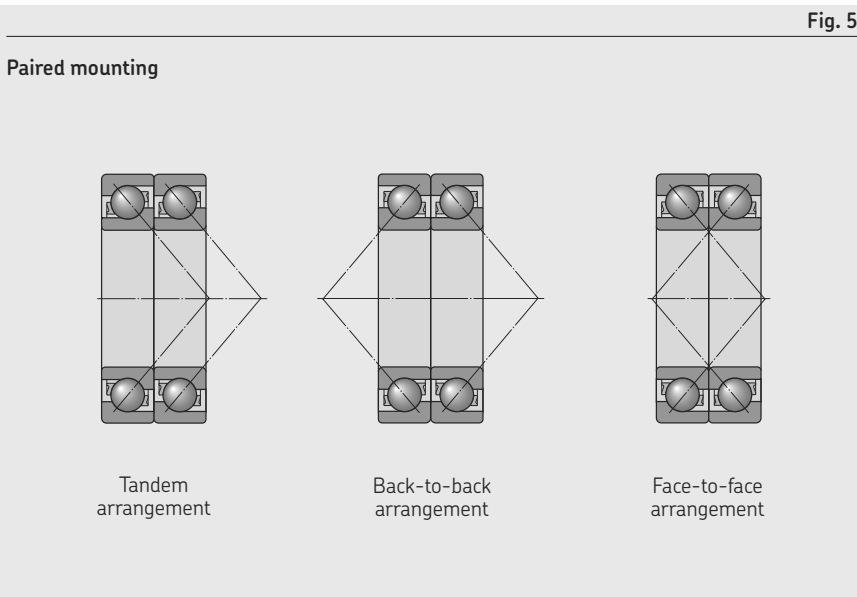
Bearings in the 52 and 53 series are no longer available and have been replaced with 32 A and 33 A series bearings, which are dimensionally interchangeable. Only size 3200 A is different, and has a width of 14 mm instead of 14,3 mm.

Basic design bearings

- have different tolerances and performance capabilities compared with SKF Explorer bearings

Bearings with a two-piece inner ring

- incorporate a larger number of balls, and have a larger contact angle, giving the bearing its high load carrying capacity, especially in the axial direction
- are separable in the 33 D series (fig. 6), i.e. the outer ring with ball and cage assemblies can be mounted independently of the inner ring halves
- are non-separable in the 33 DNRCBM series (fig. 6)
 - have a snap ring groove with a snap ring in the outer ring, enabling simple and space-saving axial location in the housing
 - have been designed specifically for centrifugal pumps, but can also be used in other applications



Four-point contact ball bearings

Four-point contact ball bearings (fig. 4, page 385) are radial single row angular contact ball bearings with raceways that are designed to support axial loads in both directions. For a given axial load, a limited radial load can also be supported (*Load ratio*, page 403). The bearings are separable, i.e. the outer ring with ball and cage assembly can be mounted separately from the two inner ring halves.

These bearings take up considerably less axial space than double row bearings.

Both inner ring halves of SKF Explorer four-point contact ball bearings have a recessed shoulder. This improves oil flow when the bearing is used in combination with an SKF cylindrical roller bearing (fig. 12, page 403). In addition, these recesses can be used to facilitate dismounting.

When four-point contact ball bearings are subjected to high clamping forces their inner ring deformation is limited.

SKF standard assortment

- bearings in the QJ 2 and QJ 3 series
- some sizes in the QJ 10 and QJ 12 series (skf.com/go/17000-3-4)

Bearings with locating slots

Four-point contact ball bearings can be supplied with two locating slots in the outer ring (designation suffix N2, fig. 7):

- preventing the bearing from turning
- positioned 180° apart

The dimensions and tolerances of the locating slots are in accordance with ISO 20515 and are listed in table 1.

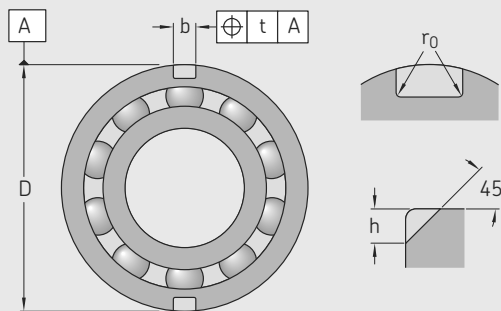
SKF Explorer bearings

For information, refer to page 7



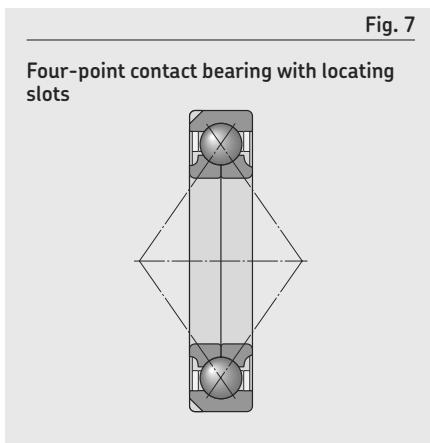
Table 1

Locating slots in the outer ring of four-point contact ball bearings



Outside diameter		Dimensions						Tolerance ¹⁾
Diameter series 2		Diameter series 2			Diameter series 3			t U
D >	D ≤	h	b	r ₀	h	b	r ₀	
mm		mm						mm
35	45	2,5	3,5	0,5	–	–	–	0,2
45	60	3	4,5	0,5	3,5	4,5	0,5	0,2
60	72	3,5	4,5	0,5	3,5	4,5	0,5	0,2
72	95	4	5,5	0,5	4	5,5	0,5	0,2
95	115	5	6,5	0,5	5	6,5	0,5	0,2
115	130	6,5	6,5	0,5	8,1	6,5	1	0,2
130	145	8,1	6,5	1	8,1	6,5	1	0,2
145	170	8,1	6,5	1	10,1	8,5	2	0,2
170	190	10,1	8,5	2	11,7	10,5	2	0,2
190	210	10,1	8,5	2	11,7	10,5	2	0,2
210	240	11,7	10,5	2	11,7	10,5	2	0,2
240	270	11,7	10,5	2	11,7	10,5	2	0,2
270	400	12,7	10,5	2	12,7	10,5	2	0,4

¹⁾ Other tolerances are in accordance with ISO 20515.



Capped bearings

SKF supplies the following angular contact ball bearings capped with a shield or seal on both sides:

- single row bearings in the 72 B(E) and 73 B(E) series:
 - non-contact seals (designation suffix 2RZ, fig. 8)
- most common double row basic design and SKF Explorer bearings:
 - shields (designation suffix 2Z, fig. 9)
 - contact seals (designation suffix 2RS1, fig. 10)

For additional information, refer to *Integral sealing*, page 26.

When capped bearings must operate under certain conditions, such as very high speeds or high temperatures, grease may appear between the inner ring and capping device. For bearing arrangements where this would be detrimental, appropriate actions should be taken.

Shields

- are made of sheet steel
- extend into a recess on the inner ring

Non-contact seals

- have no additional frictional moment
- have the same limiting speeds as open bearings
- form an extremely narrow gap with the inner ring shoulder
- are made of sheet steel reinforced NBR (oil and wear-resistant)
- make good, positive contact with the recess in which they are fitted

Contact seals

- are made of NBR
- are reinforced with a sheet steel insert
- are fitted in a recess on the outer ring and make good, positive contact with the recess
- have a lip that exerts light pressure against the recess on the inner ring to provide an effective seal

Fig. 8

Capped bearing – non-contact seals

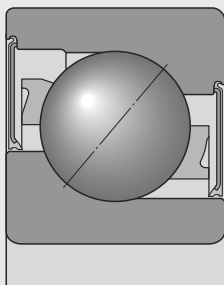


Fig. 9

Capped bearing – shields

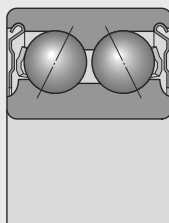
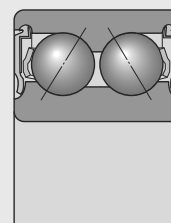


Fig. 10

Capped bearing – contact seals



Greases for capped bearings

Bearings capped on both sides are lubricated for the life of the bearing and are virtually maintenance-free. They are filled with one of the following greases (table 2):

- single row bearings
 - as standard → GXN
- double row bearings
 - as standard → GJN
 - in Europe → MT33 (commonly used and widely available)
 - low-friction grease → GE2
- other greases (table 2) can be supplied on request

The standard grease is not identified in the bearing designation (no designation suffix). Other greases are indicated by the corresponding grease suffix.

Grease life for capped bearings

Grease life for capped angular contact ball bearings can be estimated as described for deep groove ball bearings (page 246). The required grease information is provided in table 2.



Table 2

Technical specifications of SKF standard and special greases for capped angular contact ball bearings

Grease	Temperature range ¹⁾							Thickener	Base oil type	NLGI grade	Base oil viscosity [mm ² /s]		Grease performance factor (GPF)
	-50	0	50	100	150	200	250				°C	at 40 °C (105 °F)	
GXN	█	█	█	█	█	█	█	Polyurea	Mineral	2-3	96	10,5	2
GJN	█	█	█	█	█	█	█	Polyurea	Mineral	2	115	12,2	2
MT33	█	█	█	█	█	█	█	Lithium soap	Mineral	3	100	10	1
VT113	█	█	█	█	█	█	█	Lithium complex	Mineral	3	113	12,1	1
WT	█	█	█	█	█	█	█	Polyurea	Ester	2-3	70	9,4	4
GWF	█	█	█	█	█	█	█	Polyurea	Synthetic hydrocarbon	2-3	67,5	9,6	4
GE2	█	█	█	█	█	█	█	Lithium	Synthetic	2	25	4,9	2

¹⁾ Refer to the SKF traffic light concept (page 117).

Cages

SKF angular contact ball bearings are fitted with one or two (double row bearings) of the cages shown in table 3.

The standard cages of double row bearings are either made of PA66 or of stamped steel.

The machined brass cage (designation suffix M) of single row bearings has been upgraded as follows:

- optimized cage pocket geometry
- a smaller cross section and reduced mass
- increased material strength with reduced lead content

When used at high temperatures, some lubricants can have a detrimental effect on polyamide cages. For additional information about the suitability of cages, refer to *Cages*, page 187.



Cages for angular contact ball bearings

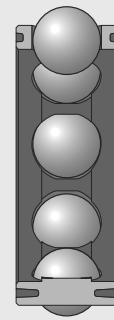
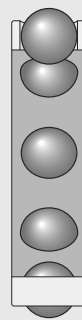
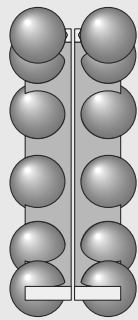
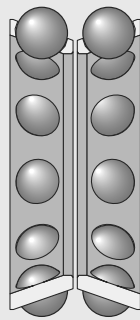
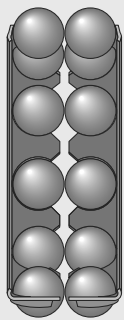
	Single row angular contact ball bearings			Double row angular contact ball bearings		
Cage type	Window-type, ball centred		Window-type, ball centred	Snap-type, ball centred	Snap-type, ball centred	
Material	PA66, glass fibre reinforced	PEEK, glass fibre reinforced	Stamped brass, stamped steel	Machined brass, machined steel ¹⁾	PA66, glass fibre reinforced	Stamped steel
Suffix	P	PH	Y, J	M, F ¹⁾	TN9	-, J1

¹⁾ Check availability prior to ordering



Table 3

Four-point contact ball bearings



Snap-type, crown, ball centred	Window-type, ball centred	Prong-type, outer ring centred	Window-type, outer ring centred	Window-type, lubrication grooves in the guiding surface, outer ring centred
Stamped steel	Machined brass	Machined brass	Machined brass	PEEK, glass fibre reinforced
–	M	MA	MA	PHAS

Bearing data

Single row angular contact ball bearings

Dimension standards	Boundary dimensions: ISO 15 and ISO 12044
Tolerances	<p>Normal Except for:</p> <ul style="list-style-type: none"> • SKF Explorer bearings: <ul style="list-style-type: none"> – P6 dimensional tolerance – P5 geometrical tolerance • Bearings with $D \geq 400$ mm: <ul style="list-style-type: none"> – P6 geometrical tolerance
For additional information → page 35	Values: ISO 492 (table 2, page 38, to table 4, page 40)
Contact angle	<ul style="list-style-type: none"> • suffix B: 40° • suffix AC: 25° <p>For availability of bearings with 30° contact angle, contact SKF.</p>
Internal clearance	<p>Single bearings Obtained after mounting, depending on adjustment against a second bearing.</p> <p>Pairs of universally matchable bearings</p> <ul style="list-style-type: none"> • CA – smaller than Normal axial clearance (table 4, page 394) • CB – Normal axial clearance (standard) (table 4) • CC – larger than Normal axial clearance (table 4) • G (standard for larger bearings) - Normal axial clearance (table 5, page 394)
For additional information → page 182	Values are valid for unmounted bearing sets, arranged back-to-back or face-to-face under zero measuring load.
Preload	<p>Single bearings Obtained after mounting, depending on adjustment against a second bearing.</p> <p>Pairs of universally matchable bearings</p> <ul style="list-style-type: none"> • GA – light preload (standard) • GB – moderate preload • GC – heavy preload
For additional information → page 182	Values (table 6, page 395) apply to unmounted bearing sets, arranged back-to-back or face-to-face.
Permissible misalignment	<p>Back-to-back: ≈ 2 minutes of arc Face-to-face: ≈ 4 minutes of arc</p> <p>Misalignment increases bearing noise and reduces bearing service life, and when it exceeds ...</p>

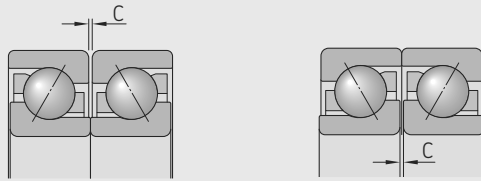


Double row angular contact ball bearings	Four-point contact ball bearings
Boundary dimensions: ISO 15 Except for: <ul style="list-style-type: none"> • bearing 3200 A: width = 14 mm instead of 14,3 mm • snap rings and grooves: ISO 464 (table 7, page 395) 	Boundary dimensions: ISO 15 Except for: <ul style="list-style-type: none"> • Locating slots: ISO 20515 (table 1, page 387)
Normal Except for: <ul style="list-style-type: none"> • SKF Explorer bearings and 33 DNRCBM series: <ul style="list-style-type: none"> – P6 	Normal P6 geometrical tolerance on request Except for: <ul style="list-style-type: none"> • SKF Explorer bearings: <ul style="list-style-type: none"> – P6 – width tolerance reduced to 0/–40 µm
<ul style="list-style-type: none"> • 32 A and 33 A series: 30° • 33 D series: 45° • 33 DNRCBM series: 40° 	<ul style="list-style-type: none"> • 35°
Normal Check availability of C2, C3 or C4 clearance classes Values: (table 8, page 396) Values are valid for unmounted bearings under zero measuring load.	Normal Check availability of C2, C3, C4 or reduced ranges of standard clearance classes Values: ISO 5753-2 (table 9, page 397)
–	–
≈ 2 minutes of arc	≈ 2 minutes of arc
... the guideline values, these effects become particularly noticeable.	

3 Angular contact ball bearings

Table 4

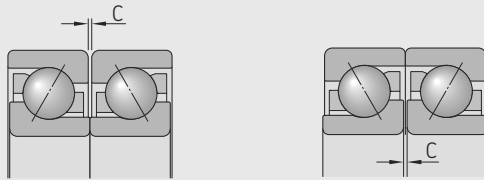
Axial internal clearance of universally matchable single row angular contact ball bearings arranged back-to-back or face-to-face



Bore diameter		Axial internal clearance					
d	> ≤	Class CA		Class CB		Class CC	
		min.	max.	min.	max.	min.	max.
mm		μm					
–	18	5	13	15	23	24	32
18	30	7	15	18	26	32	40
30	50	9	17	22	30	40	48
50	80	11	23	26	38	48	60
80	120	14	26	32	44	55	67
120	160	17	29	35	47	62	74
160	180	17	29	35	47	62	74
180	250	21	37	45	61	74	90
250	315	26	42	52	68	90	106

Table 5

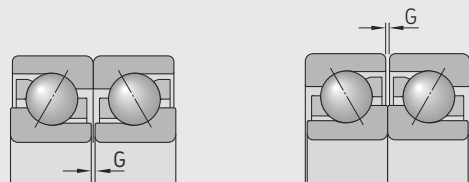
Axial internal clearance of G design universally matchable single row angular contact ball bearings arranged back-to-back or face-to-face



Bore diameter		Axial internal clearance of bearings in the series														
d	> ≤	718A		719A		70A		70 B		72 B		73 B		74 B		
		min.	max.	min.	max.	min.	max.	min.	max.	min.	max.	min.	max.	min.	max.	
mm		μm														
30	60	–	–	–	–	–	–	–	–	–	–	–	–	–	24	64
60	70	–	–	–	–	–	–	–	–	–	–	–	–	–	24	74
100	160	–	–	–	–	24	76	26	76	–	–	–	–	–	–	–
160	240	–	–	–	–	15	68	20	72	–	–	–	–	–	–	–
240	280	15	68	15	68	15	68	20	72	30	80	–	–	–	–	–
280	300	15	68	15	68	30	80	30	80	30	80	–	–	–	–	–
300	340	15	68	30	80	30	80	30	80	30	80	40	100	–	–	–
340	400	15	68	40	100	40	100	40	100	30	80	60	120	–	–	–
400	420	40	100	40	100	40	100	40	100	40	100	60	120	–	–	–
420	460	40	100	40	100	40	100	40	100	60	120	60	120	–	–	–
460	500	60	120	60	120	60	120	60	120	60	120	60	120	–	–	–
500	750	–	–	–	–	160	260	–	–	–	–	–	–	–	–	–

Table 6

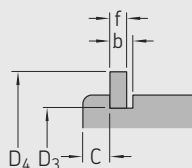
Preload of universally matchable single row angular contact ball bearings arranged back-to-back or face-to-face



Bore diameter		Preload Class		GB		GC	
d		GA		min.	max.	min.	max.
>	≤	min.	max.	min.	max.	min.	max.
mm		μm		μm		μm	
10	18	+4	-4	-2	-10	-8	-16
18	30	+4	-4	-2	-10	-8	-16
30	50	+4	-4	-2	-10	-8	-16
50	80	+6	-6	-3	-15	-12	-24
80	120	+6	-6	-3	-15	-12	-24
120	180	+6	-6	-3	-15	-12	-24
180	250	+8	-8	-4	-20	-16	-32
250	315	+8	-8	-4	-20	-16	-32

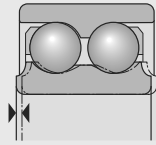
Table 7

Dimensions of snap ring grooves and snap rings



Bearing Designation	Dimensions					Snap ring Designation
	C	b	f	D ₃	D ₄	
–	mm					–
3308 DNRCBM	3,28	2,7	2,46	86,8	96,5	SP 90
3309 DNRCBM	3,28	2,7	2,46	96,8	106,5	SP 100
3310 DNRCBM	3,28	2,7	2,46	106,8	116,6	SP 110
3311 DNRCBM	4,06	3,1	2,82	115,2	129,7	SP 120
3313 DNRCBM	4,9	3,1	2,82	135,2	149,7	SP 140

Axial internal clearance of double row angular contact ball bearings



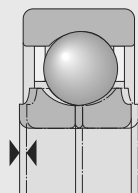
3



Bore diameter		Axial internal clearance of bearings in the series								33 D		33 DNRCBM	
d		32 A and 33 A		Normal		C3		C4		min.	max.	min.	max.
>	≤	min.	max.	min.	max.	min.	max.	min.	max.				
mm		μm											
–	10	1	11	5	21	12	28	25	45	25	45	–	–
10	18	1	12	6	23	13	31	27	47	27	47	–	–
18	24	2	14	7	25	16	34	28	48	27	47	6	26
24	30	2	15	8	27	18	37	30	50	30	50	6	26
30	40	2	16	9	29	21	40	33	54	33	54	10	30
40	50	2	18	11	33	23	44	36	58	36	58	10	30
50	65	3	22	13	36	26	48	40	63	40	63	18	38
65	80	3	24	15	40	30	54	46	71	46	71	18	38
80	100	3	26	18	46	35	63	55	83	55	83	–	–
100	110	4	30	22	53	42	73	65	96	65	96	–	–

Table 9

Axial internal clearance of four-point contact ball bearings



Bore diameter d		Axial internal clearance							
>	≤	C2		Normal		C3		C4	
		min.	max.	min.	max.	min.	max.	min.	max.
mm		μm							
10	18	15	65	50	95	85	130	120	165
18	40	25	75	65	110	100	150	135	185
40	60	35	85	75	125	110	165	150	200
60	80	45	100	85	140	125	175	165	215
80	100	55	110	95	150	135	190	180	235
100	140	70	130	115	175	160	220	205	265
140	180	90	155	135	200	185	250	235	300
180	220	105	175	155	225	210	280	260	330
220	260	120	195	175	250	230	305	290	360
260	300	135	215	195	275	255	335	315	390
300	350	155	240	220	305	285	370	350	430
350	400	175	265	245	330	310	400	380	470
400	450	190	285	265	360	340	435	415	510
450	500	210	310	290	390	365	470	445	545



Loads

	Single row angular contact ball bearings	Double row angular contact ball bearings
Minimum load	Minimum axial load for single bearings and bearing pairs arranged in tandem: $F_{am} = A \left(\frac{n}{1\,000} \right)^2$	–
For additional information → page 106	Minimum radial load for bearing pairs arranged back-to-back or face-to-face: $F_{rm} = k_r \left(\frac{v n}{1\,000} \right)^{2/3} \left(\frac{d_m}{100} \right)^2$	Minimum radial load: $F_{rm} = k_r \left(\frac{v n}{1\,000} \right)^{2/3} \left(\frac{d_m}{100} \right)^2$
Equivalent dynamic bearing load	Single bearings and bearing pairs arranged in tandem: $F_a/F_r \leq e \rightarrow P = F_r$ $F_a/F_r > e \rightarrow P = X F_r + Y_2 F_a$ When determining the axial load F_a , refer to <i>Calculating the axial load for bearings mounted singly or paired in tandem</i> page 400. Bearing pairs arranged back-to-back or face-to-face: $F_a/F_r \leq e \rightarrow P = F_r + Y_1 F_a$ $F_a/F_r > e \rightarrow P = X F_r + Y_2 F_a$	$F_a/F_r \leq e \rightarrow P = F_r + Y_1 F_a$ $F_a/F_r > e \rightarrow P = X F_r + Y_2 F_a$
For additional information → page 91		
Equivalent static bearing load	Single bearings and bearing pairs arranged in tandem: $P_0 = 0,5 F_r + Y_0 F_a$ $P_0 < F_r \rightarrow P_0 = F_r$ When determining the axial load F_a , refer to <i>Calculating the axial load for bearings mounted singly or paired in tandem</i> , page 400. Bearing pairs arranged back-to-back or face-to-face: $P_0 = F_r + Y_0 F_a$	$P_0 = F_r + Y_0 F_a$
For additional information → page 105		



Four-point contact ball bearings

Minimum axial load:

$$F_{am} = A \left(\frac{n}{1\,000} \right)^2$$

–

Locating bearings to accommodate radial and axial load:

$$F_a/F_r \leq 0,95 \rightarrow P = F_r + 0,66 F_a$$

$$F_a/F_r > 0,95 \rightarrow P = 0,6 F_r + 1,07 F_a$$

For a proper functionality, SKF recommends

$$F_a \geq 1,27 F_r.$$

Thrust bearings with radial clearance in the housing in combination with a radial bearing (fig. 12, page 403):

$$P = 1,07 F_a$$

$$P_0 = F_r + 0,58 F_a$$

Symbols

- A minimum axial load factor (product tables)
 - Single row bearings, page 406
 - Four-point contact bearings, page 430
- d_m bearing mean diameter [mm]
 - = 0,5 (d + D)
- e calculation factor for single and double row bearings (table 10, page 400)
- F_a axial load [kN]
- F_{am} minimum axial load [kN]
- F_r radial load [kN]
- F_{rm} minimum radial load [kN]
- k_r minimum radial load factor (product tables)
 - Single row bearings, page 406
 - Double row bearings, page 424
- n rotational speed [r/min]
- P equivalent dynamic bearing load [kN]
- P_0 equivalent static bearing load [kN]
- X, Y_0 , Y_1 , Y_2 calculation factors for single and double row bearings (table 10)
- ν actual operating viscosity of the lubricant [mm²/s]

Calculating the axial load for bearings mounted singly or paired in tandem

When a radial load is applied to a single row angular contact ball bearing, the load is transmitted from one raceway to the other at an angle to the bearing axis and an internal axial load is induced. This must be considered when calculating the equivalent bearing loads for bearings in adjusted arrangements consisting of two single bearings and/or bearing pairs arranged in tandem.

The equations (**table 11**) are only valid if the bearings have identical contact angles and are adjusted against each other to practically zero clearance, but without any preload. In the table, bearing A is subjected to a radial load F_{rA} and bearing B to a radial load F_{rB} . Both F_{rA} and F_{rB} are always considered positive, even when they act in the direction opposite to that shown in the figures. The radial loads act at the pressure centres of the bearings (distance a , refer to **product tables, page 406**).

These calculations can easily be done with SKF's online calculation tools. When the bearings are adjusted with clearance or preload, or when bearings with different contact angles are used, the equations become more complex and can be done using the SKF SimPro platform (skf.com/simpro).

Load carrying capacity of bearing pairs

The values for basic load ratings and fatigue load limits listed in the **product tables, page 406**, apply to single bearings. For bearing pairs mounted immediately adjacent to each other, the following values apply:

- basic dynamic load rating for standard bearings in all arrangements and for SKF Explorer bearings in a back-to-back or face-to-face arrangement
 $C = 1,62 C_{\text{single bearing}}$
- basic dynamic load rating for SKF Explorer bearings in a tandem arrangement
 $C = 2 C_{\text{single bearing}}$
- basic static load rating
 $C_0 = 2 C_{0 \text{ single bearing}}$
- fatigue load limit
 $P_u = 2 P_{u \text{ single bearing}}$

3



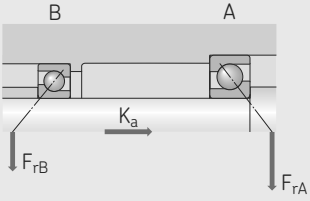
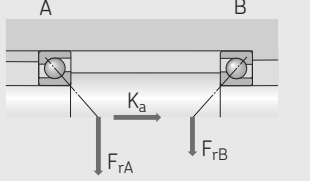
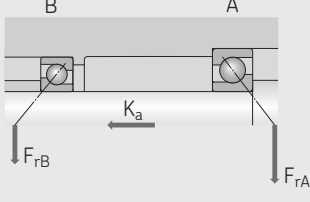
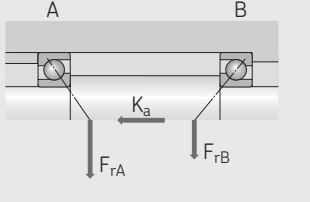
Table 10

Calculation factors for single and double row angular contact ball bearings

Bearing types	Calculation factor				
	e	X	Y ₁	Y ₂	Y ₀
Single row bearings					
Single bearings or bearing pairs arranged in tandem					
Suffix B	1,4	0,35	–	0,57	0,26
Suffix AC	0,68	0,41	–	0,87	0,38
Bearing pairs arranged back-to-back or face-to-face					
Suffix B	1,14	0,57	0,55	0,93	0,52
Suffix AC	0,68	0,67	0,92	1,41	0,76
Double row bearings					
Series 32 A, 33 A	0,8	0,63	0,78	1,24	0,66
Series 33 D	1,34	0,54	0,47	0,81	0,44
Series 33 DNRCBM	1,14	0,57	0,55	0,93	0,52

Table 11

Axial loading of bearing arrangements incorporating two single row angular contact ball bearings and/or bearing pairs in tandem

Bearing arrangement	Load case	Axial loads	
<p>Back-to-back</p> 	<p>Case 1a</p> $F_{rA} \geq F_{rB}$ $K_a \geq 0$	$F_{aA} = R F_{rA}$	$F_{aB} = F_{aA} + K_a$
<p>Face-to-face</p> 	<p>Case 1b</p> $F_{rA} < F_{rB}$ $K_a \geq R(F_{rB} - F_{rA})$	$F_{aA} = R F_{rA}$	$F_{aB} = F_{aA} + K_a$
	<p>Case 1c</p> $F_{rA} < F_{rB}$ $K_a < R(F_{rB} - F_{rA})$	$F_{aA} = F_{aB} - K_a$	$F_{aB} = R F_{rB}$
<p>Back-to-back</p> 	<p>Case 2a</p> $F_{rA} \leq F_{rB}$ $K_a \geq 0$	$F_{aA} = F_{aB} + K_a$	$F_{aB} = R F_{rB}$
<p>Face-to-face</p> 	<p>Case 2b</p> $F_{rA} > F_{rB}$ $K_a \geq R(F_{rA} - F_{rB})$	$F_{aA} = F_{aB} + K_a$	$F_{aB} = R F_{rB}$
	<p>Case 2c</p> $F_{rA} > F_{rB}$ $K_a < R(F_{rA} - F_{rB})$	$F_{aA} = R F_{rA}$	$F_{aB} = F_{aA} - K_a$

For bearings with:
 • 20° contact angle → R = 0,50
 • 25° contact angle → R = 0,57
 • 30° contact angle → R = 0,66
 • 40° contact angle → R = 0,88



Temperature limits

The permissible operating temperature for angular contact ball bearings can be limited by:

- the dimensional stability of the bearing rings and balls
- the cage
- the seals
- the lubricant

Where temperatures outside the permissible range are expected, contact SKF.

Bearing rings and balls

The bearings are heat stabilized up to at least 150 °C (300 °F).

Cages

Steel, brass or PEEK cages can be used at the same operating temperatures as the bearing rings and balls. For temperature limits of cages made of other polymer materials, refer to *Polymer cages*, page 188.

Seals

The permissible operating temperature for NBR seals is -40 to +100 °C (-40 to +210 °F). Temperatures up to 120 °C (250 °F) can be tolerated for brief periods.

Typically, temperature peaks are at the seal lip.

Lubricants

Temperature limits for greases used in sealed SKF angular contact ball bearings are provided in table 2, page 389. For temperature limits of other SKF greases, refer to *Selecting a suitable SKF grease*, page 116.

When using lubricants not supplied by SKF, temperature limits should be evaluated according to the SKF traffic light concept (page 117).

Permissible speed

The speed ratings in the product tables indicate:

- the **reference speed**, which enables a quick assessment of the speed capabilities from a thermal frame of reference
- the **limiting speed**, which is a mechanical limit that should not be exceeded unless the bearing design and the application are adapted for higher speeds

For additional information, refer to *Operating temperature and speed*, page 130.

SKF recommends oil lubrication for bearings with a ring centred cage (designation suffix MA or PHAS). When these bearings are grease lubricated, the nd_m value is limited to 250 000 mm/min.

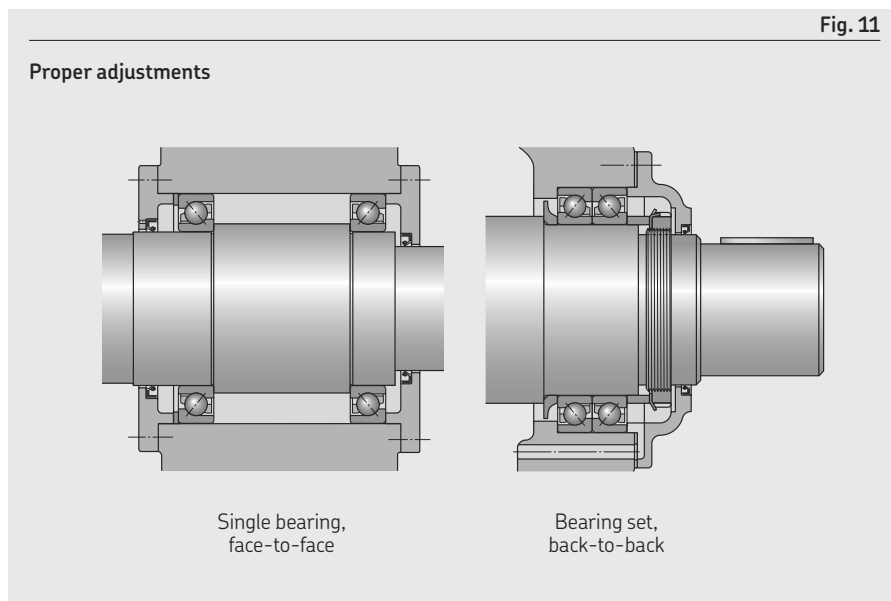
where

$$d_m = \text{bearing mean diameter [mm]} \\ = 0,5 (d + D)$$

$$n = \text{rotational speed [r/min]}$$

Bearing pairs

For bearings arranged in pairs, the limiting speed should be reduced to approximately 80% of the value quoted for a single bearing.



Design considerations

Single row angular contact ball bearings

Proper adjustment

Single row angular contact ball bearings must be used (fig. 11):

- with a second bearing
- in sets

The bearings must be adjusted against each other until the requisite clearance or preload is obtained (*Selecting preload*, page 186).

Universally matchable bearings mounted immediately adjacent to each other:

- require no further adjustment (*Bearings for universal matching*, page 385)
- obtain requisite clearance or preload by:
 - choosing bearings from an appropriate clearance or preload class
 - applying suitable fits for the bearings on the shaft and in the housing

Performance and operational reliability depend on:

- proper adjustment for single bearings
- the correct selection of clearance and preload for universally matchable bearings

If there is too much clearance in the bearing arrangement during operation, the load carrying capacity of the bearings will not be fully utilized. Excessive preload produces more friction and higher operating temperatures, leading to a reduction in bearing service life.

Axial loads in one direction

When the axial load acts predominantly in one direction in back-to-back and face-to-face arrangements, unfavourable rolling conditions for the balls of the axially unloaded bearing may occur, which can lead to:

- increased noise levels
- discontinuity in the lubricant film
- increased stresses on the cage

Under these circumstances, SKF recommends zero operating clearance, which can be attained by using springs. When springs are not sufficient, using bearings with a 25° contact angle as a backup bearing may help.

Load ratio

- of $F_a/F_r \geq 1$ is required by bearings in the 70 B, 72 B(E) and 73 B(E) series
- of $F_a/F_r \geq 0,55$ is required by bearings in the 72 AC and 73 AC series

If the load ratio requirement is not met in each case, bearing service life can be reduced.

Four-point contact ball bearings

Used as a thrust bearing

Four-point contact ball bearings are often used as entirely thrust bearings, together with a radial bearing. When used in this way, the four-point contact ball bearing should be mounted with radial clearance in the housing (fig. 12).

- in combination with a cylindrical roller bearing:
 - the radial internal clearance of the cylindrical roller bearing should be smaller than the theoretical radial internal clearance of the four-point contact ball bearing after both have been mounted
 - the theoretical radial clearance can be calculated from:

$$C_r = 0,7 C_a$$

where

C_r = theoretical radial internal clearance
 C_a = axial internal clearance (table 9, page 397)

- the outer ring of the four-point contact ball bearing must be able to accommodate thermal movements
 - Therefore, it should not be clamped axially, but a small gap should be maintained between the outer ring and the cover flange.
- bearings with locating slots should be used (fig. 12) to prevent the outer ring from turning
 - If clamping the outer ring cannot be avoided, the outer ring must be carefully centred during mounting.

Load ratio

For proper functionality, the balls should contact only one inner ring raceway and the opposite side of the outer ring raceway. This is the case when the load ratio is $F_a/F_r \geq 1,27$.

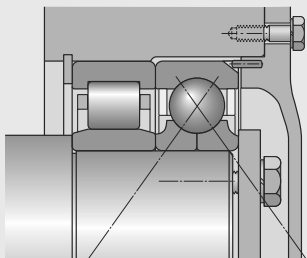
A load ratio that is smaller than recommended can reduce bearing service life.

3

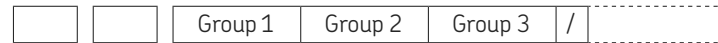


Fig. 12

Bearing mounted with radial clearance in the housing



Designation system



Prefixes

Basic designation

Listed in table 4, page 30

- ALS Inch bearing
- AMS Inch bearing

Suffixes

Group 1: Internal design

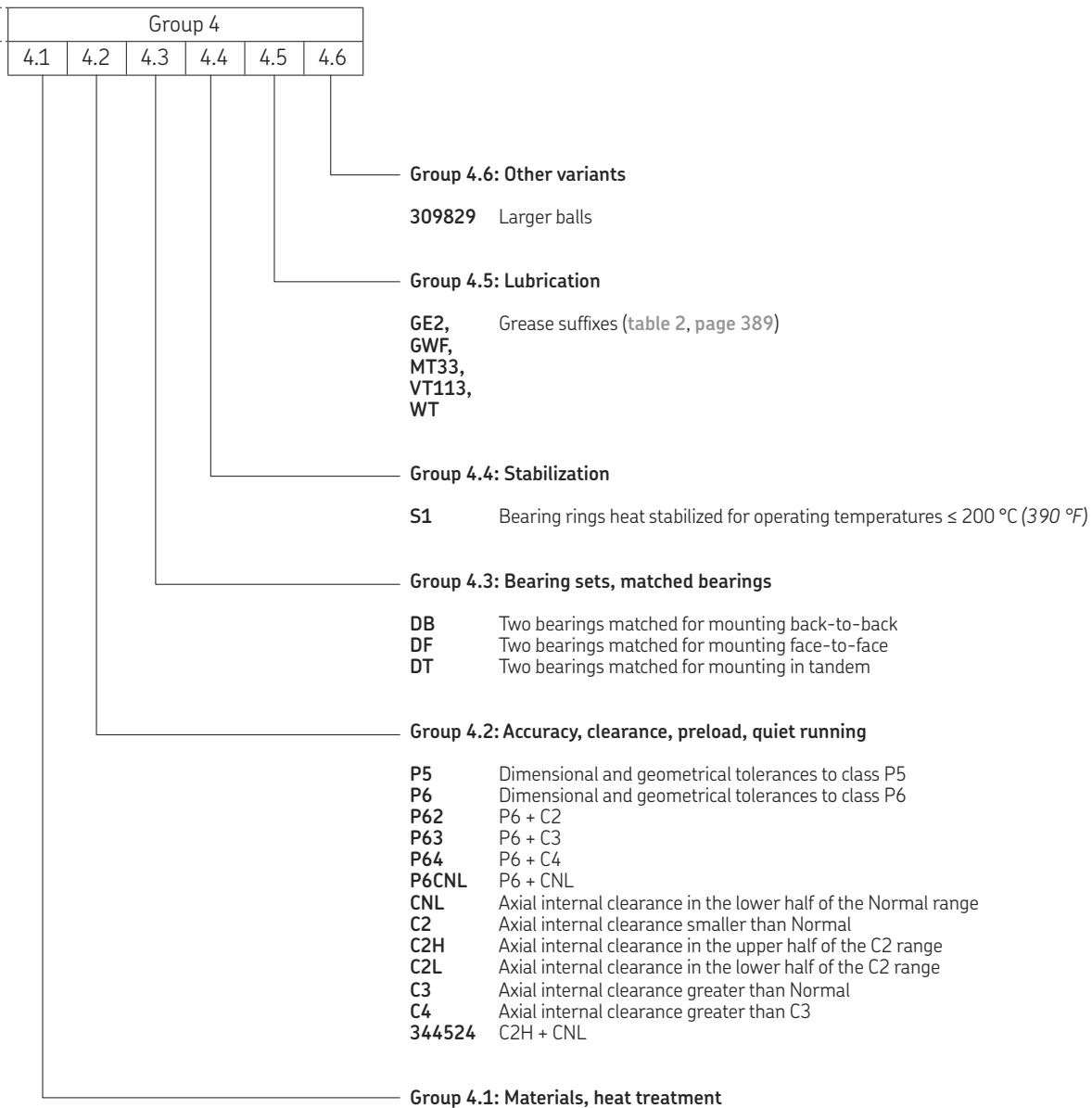
- A Single row bearing, 30° contact angle
- A Double row bearing, no filling slots
- AB Single row inch bearing, 20° contact angle
- AC Single row bearing, 25° contact angle
- B Single row bearing, 40° contact angle
- D Two-piece inner ring
- E Optimized internal design

Group 2: External design (seals, snap ring groove, execution, etc.)

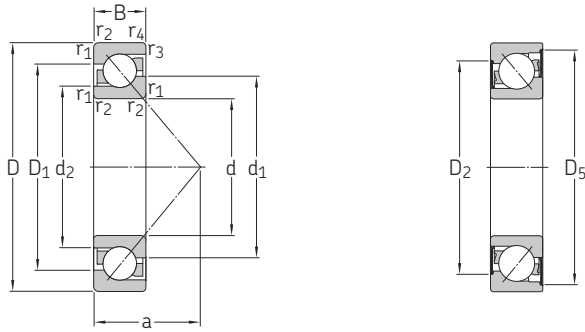
- N Snap ring groove in the outer ring
- NR Snap ring groove in the outer ring, with appropriate snap ring
- N1 One locating slot (notch) in one outer ring side face
- N2 Two locating slots (notches) in one outer ring side face, 180° apart
- CB Double row bearing, controlled axial internal clearance
- CA Bearing for universal matching. Two bearings arranged back-to-back or face-to-face have axial internal clearance smaller than Normal (CB).
- CB Bearing for universal matching. Two bearings arranged back-to-back or face-to-face have Normal axial internal clearance.
- CC Bearing for universal matching. Two bearings arranged back-to-back or face-to-face have axial internal clearance greater than Normal (CB).
- G Bearing for universal matching. Two bearings arranged back-to-back or face-to-face have axial internal clearance.
- GA Bearing for universal matching. Two bearings arranged back-to-back or face-to-face have light preload.
- GB Bearing for universal matching. Two bearings arranged back-to-back or face-to-face have moderate preload.
- GC Bearing for universal matching. Two bearings arranged back-to-back or face-to-face have heavy preload.
- 2RS1 Contact seal, NBR, on both sides
- 2RZ Non-contact seal, NBR, on both sides
- ZZ Shield on both sides

Group 3: Cage design

- Stamped steel cage, ball centred (double row bearing)
- F Machined steel cage, ball centred
- FA Machined steel cage, outer ring centred
- J Stamped steel cage, ball centred (single row bearing)
- J1 Stamped steel cage, ball centred (double row bearing with a two-piece inner ring)
- M Machined brass cage, ball centred; different designs are identified by a number following the M, e.g. M2
- MA Machined brass cage, outer ring centred.
- MB Machined brass cage, inner ring centred
- P Glass fibre reinforced PA66 cage, ball centred
- PH Glass fibre reinforced PEEK cage, ball centred
- PHAS Glass fibre reinforced PEEK cage, with lubrication grooves in the guiding surfaces, outer ring centred
- TN9 Glass fibre reinforced PA66 cage, ball centred
- Y Stamped brass cage, ball centred



3.1 Single row angular contact ball bearings d 10 – 20 mm

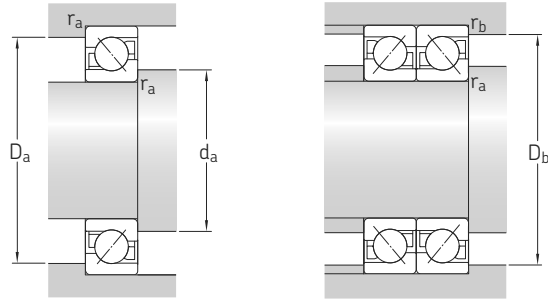


2RZ

3.1

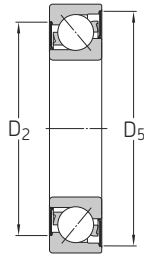
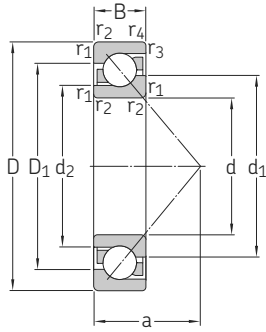


Principal dimensions			Basic load ratings		Fatigue load limit	Speed ratings		Mass	Designations Universally matchable bearing	Basic design / sealed bearing
d	D	B	C	C ₀		Reference speed	Limiting speed			
mm			kN		kN	r/min	kg	–		
10	30	9	7,02	3,35	0,14	30 000	30 000	0,03	▶ 7200 BECBP	▶ 7200 BEP
12	32	10	7,61	3,8	0,16	28 000	26 000	0,036	▶ 7201 BECBP	▶ 7201 BEP
	37	12	10,6	5	0,208	26 000	20 000	0,06	–	▶ 7301 BE-2RZP
	37	12	10,6	5	0,208	26 000	24 000	0,06	–	▶ 7301 BEP
15	35	11	8,32	4,4	0,183	24 000	20 000	0,045	–	▶ 7202 BE-2RZP
	35	11	8,32	4,4	0,183	24 000	24 000	0,045	–	▶ 7202 BEP
	35	11	8,8	4,65	0,196	24 000	26 000	0,045	▶ 7202 BECBP	–
	35	11	10,2	5,2	0,224	26 000	40 000	0,045	7202 ACCBM	–
	42	13	13	6,7	0,28	22 000	17 000	0,082	–	▶ 7302 BE-2RZP
	42	13	13	6,7	0,28	22 000	20 000	0,08	▶ 7302 BECBP	▶ 7302 BEP
17	40	12	10,4	5,5	0,236	22 000	17 000	0,063	–	▶ 7203 BE-2RZP
	40	12	10,4	5,5	0,236	22 000	20 000	0,065	–	▶ 7203 BEP
	40	12	11	5,85	0,25	22 000	22 000	0,065	▶ 7203 BECBP	–
	40	12	11	5,85	0,25	22 000	28 000	0,065	▶ 7203 BECBM	–
	40	12	11,1	6,1	0,26	22 000	20 000	0,065	–	7203 BEY
	40	12	12,5	6,7	0,285	24 000	34 000	0,065	7203 ACCBM	–
	47	14	15,9	8,3	0,355	20 000	15 000	0,11	–	▶ 7303 BE-2RZP
47	14	15,9	8,3	0,355	20 000	19 000	0,11	▶ 7303 BECBP	▶ 7303 BEP	
20	47	14	13,3	7,65	0,325	19 000	14 000	0,15	–	▶ 7204 BE-2RZP
	47	14	13,3	7,65	0,325	19 000	18 000	0,11	–	▶ 7204 BEP
	47	14	14,3	8,15	0,345	19 000	19 000	0,11	▶ 7204 BECBP	–
	47	14	14,3	8,15	0,345	19 000	19 000	0,11	7204 BECBPH	–
	47	14	14,3	8,15	0,345	19 000	19 000	0,11	▶ 7204 BECBY	–
	47	14	14,3	8,15	0,345	19 000	24 000	0,11	▶ 7204 BECBM	–
	47	14	16	9,3	0,39	20 000	30 000	0,11	7204 ACCBM	–
	52	15	17,4	9,5	0,4	17 000	13 000	0,14	–	▶ 7304 BE-2RZP
	52	15	17,4	9,5	0,4	17 000	16 000	0,14	–	▶ 7304 BEP
	52	15	19	10	0,425	17 000	18 000	0,14	▶ 7304 BECBP	–
	52	15	19	10	0,425	17 000	18 000	0,14	7304 BECBPH	–
	52	15	19	10	0,425	17 000	22 000	0,14	▶ 7304 BECBM	–
52	15	20,4	11,2	0,475	17 000	18 000	0,14	▶ 7304 BECBY	–	
52	15	20,8	11,2	0,475	19 000	26 000	0,14	▶ 7304 ACCBM	–	



Dimensions								Abutment and fillet dimensions						Calculation factors	
d	d ₁ ≈	d ₂ ≈	D ₁ , D ₂ ≈	D ₅ ≈	r _{1,2} min.	r _{3,4} min.	a	d _a min.	d _a max.	D _a max.	D _b max.	r _a max.	r _b max.	A	k _r
mm								mm						-	
10	18,3	14,5	22,9	-	0,6	0,3	13	14,2	-	25,8	27,6	0,6	0,3	0,000 224	0,095
12	20,2	16,5	25	-	0,6	0,3	14	16,2	-	27,8	30	0,6	0,3	0,000 283	0,095
	21,9	16,9	29,5	33,5	1	0,6	16,3	17,6	21,5	31,4	32,8	1	0,6	0,000 537	0,1
	21,7	16,9	28,3	-	1	0,6	16,3	17,6	-	31,4	32,8	1	0,6	0,000 537	0,1
15	22,7	18,9	28,5	32,4	0,6	0,3	16	19,2	22,5	30,8	32,6	0,6	0,3	0,000 383	0,095
	22,7	18,9	27,8	-	0,6	0,3	16	19,2	-	30,8	32,6	0,6	0,3	0,000 383	0,095
	22,7	18,9	27,8	-	0,6	0,3	16	19,2	-	30,8	32,6	0,6	0,3	0,000 383	0,095
	22,8	18,8	27,6	-	0,6	0,3	16	19,2	-	30,8	32,6	0,6	0,3	0,000 156	0,095
	26	20,7	33,8	38,6	1	0,6	18,6	21	25,5	36	38	1	0,6	0,000 907	0,1
17	26,2	21,6	34	36,5	0,6	0,6	18	21,2	26,2	35,8	35,8	0,6	0,6	0,000 625	0,095
	26,2	21,6	31,2	-	0,6	0,6	18	21,2	-	35,8	35,8	0,6	0,6	0,000 625	0,095
20	26,2	21,6	31,2	-	0,6	0,6	18	21,2	-	35,8	35,8	0,6	0,6	0,000 625	0,095
	26,2	21,6	31,2	-	0,6	0,6	18	21,2	-	35,8	35,8	0,6	0,6	0,000 687	0,095
	26	21,5	31,4	-	0,6	0,6	12	21,2	-	35,8	35,8	0,6	0,6	0,000 254	0,095
	28,6	22,8	37,4	42,6	1	0,6	20,4	22,6	28	41,4	42,8	1	0,6	0,00141	0,1
	28,6	22,8	36,2	-	1	0,6	20,4	22,6	-	41,4	42,8	1	0,6	0,00141	0,1
	30,8	25,8	37,7	43,2	1	0,6	21	25,6	30	41,4	42,8	1	0,6	0,00113	0,095
	30,8	25,8	37	-	1	0,6	21	25,6	-	41,4	42,8	1	0,6	0,00113	0,095
	30,8	25,8	37	-	1	0,6	21	25,6	-	41,4	42,8	1	0,6	0,00113	0,095
	30,8	25,8	37	-	1	0,6	21	25,6	-	41,4	42,8	1	0,6	0,00113	0,095
	30,7	25,7	36,7	-	1	0,6	14	25,6	-	41,4	42,8	1	0,6	0,000 461	0,095
33,1	26,7	41,6	48,1	1,1	0,6	22,8	27	30,5	45	47,8	1	0,6	0,00191	0,1	
33,1	26,7	40,5	-	1,1	0,6	22,8	27	-	45	47,8	1	0,6	0,00191	0,1	
33,1	26,7	40,5	-	1,1	0,6	22,8	27	-	45	47,8	1	0,6	0,00191	0,1	
33,1	26,7	40,5	-	1,1	0,6	22,8	27	-	45	47,8	1	0,6	0,00191	0,1	
33,1	26,7	40,5	-	1,1	0,6	22,8	27	-	45	47,8	1	0,6	0,00191	0,1	
33,1	26,7	40,5	-	1,1	0,6	22,8	27	-	45	47,8	1	0,6	0,00212	0,1	
32,9	26,6	40,4	-	1,1	0,6	15	27	-	45	47,8	1	0,6	0,000 771	0,1	

3.1 Single row angular contact ball bearings d 25 – 30 mm

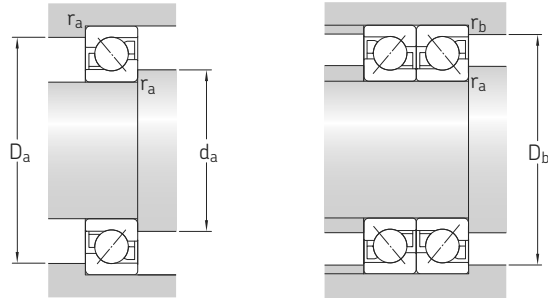


2RZ

3.1

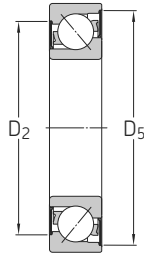
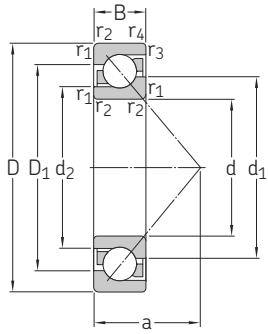


Principal dimensions			Basic load ratings		Fatigue load limit	Speed ratings		Mass	Designations Universally matchable bearing	Basic design / sealed bearing	
d	D	B	C	C ₀		Reference speed	Limiting speed				
mm			kN		kN	r/min		kg	–		
25	52	15	14,8	9,3	0,4	16 000	12 000	0,13	–	▶ 7205 BE-2RZP	
	52	15	14,8	9,3	0,4	16 000	15 000	0,13	–	▶ 7205 BEP	
	52	15	14,8	9,3	0,4	16 000	15 000	0,13	–	▶ 7205 BEY	
	52	15	15,6	10	0,43	16 000	17 000	0,13	▶ 7205 BECBP	–	
	52	15	15,6	10	0,43	16 000	17 000	0,13	▶ 7205 BECBY	–	
	52	15	15,6	10	0,43	16 000	20 000	0,13	▶ 7205 BECBM	–	
	52	15	15,6	10	0,43	16 000	17 000	0,13	7205 BECBPH	–	
	52	15	18	11,4	0,49	17 000	26 000	0,13	7205 ACCBM	–	
	62	17	24,2	14	0,6	14 000	11 000	0,23	–	▶ 7305 BE-2RZP	
	62	17	24,2	14	0,6	14 000	14 000	0,23	–	▶ 7305 BEP	
	62	17	24,2	14	0,6	14 000	14 000	0,23	–	7305 BEY	
	62	17	26,5	15,3	0,655	14 000	15 000	0,23	▶ 7305 BECBP	–	
	62	17	26,5	15,3	0,655	14 000	15 000	0,23	7305 BECBPH	–	
	62	17	26,5	15,3	0,655	14 000	15 000	0,23	▶ 7305 BECBY	–	
	62	17	26,5	15,3	0,655	14 000	19 000	0,23	▶ 7305 BECBM	–	
	62	17	29	17	0,72	15 000	22 000	0,23	▶ 7305 ACCBM	–	
	30	62	16	22,5	14,3	0,61	13 000	10 000	0,26	–	▶ 7206 BE-2RZP
		62	16	22,5	14,3	0,61	13 000	13 000	0,2	–	▶ 7206 BEP
62		16	24	15,6	0,655	13 000	14 000	0,2	▶ 7206 BECBP	–	
62		16	24	15,6	0,655	13 000	14 000	0,2	7206 BECBPH	–	
62		16	24	15,6	0,655	13 000	18 000	0,2	▶ 7206 BECBM	–	
62		16	25,5	17	0,71	13 000	14 000	0,2	▶ 7206 BECBY	–	
62		16	27,5	17,3	0,735	15 000	20 000	0,2	7206 ACCBM	–	
72		19	32,5	19,3	0,815	12 000	9 500	0,35	–	▶ 7306 BE-2RZP	
72		19	32,5	19,3	0,815	12 000	12 000	0,34	–	▶ 7306 BEP	
72		19	35,5	21,2	0,9	12 000	13 000	0,34	▶ 7306 BECBP	–	
72		19	35,5	21,2	0,9	12 000	13 000	0,34	7306 BEGAPH	–	
72		19	35,5	21,2	0,9	12 000	16 000	0,34	▶ 7306 BECBM	–	
72		19	37,5	23,2	0,98	12 000	13 000	0,34	▶ 7306 BECBY	–	
72		19	39	23,6	1	13 000	19 000	0,34	▶ 7306 ACCBM	–	



Dimensions								Abutment and fillet dimensions						Calculation factors	
d	d ₁ ≈	d ₂ ≈	D ₁ , D ₂ ≈	D ₅ ≈	r _{1,2} min.	r _{3,4} min.	a	d _a min.	d _a max.	D _a max.	D _b max.	r _a max.	r _b max.	A	k _r
mm								mm						-	
25	36,1	30,8	42,7	48	1	0,6	24	30,6	35,5	46,4	47,8	1	0,6	0,00159	0,095
	36,1	30,8	41,6	-	1	0,6	24	30,6	-	46,4	47,8	1	0,6	0,00159	0,095
	36,1	30,8	41,6	-	1	0,6	24	30,6	-	46,4	47,8	1	0,6	0,00159	0,095
	36,1	30,8	41,5	-	1	0,6	24	30,6	-	46,4	47,8	1	0,6	0,00159	0,095
	36,1	30,8	41,5	-	1	0,6	24	30,6	-	46,4	47,8	1	0,6	0,00159	0,095
	36,1	30,8	41,5	-	1	0,6	24	30,6	-	46,4	47,8	1	0,6	0,00159	0,095
	36,1	30,8	41,5	-	1	0,6	24	30,6	-	46,4	47,8	1	0,6	0,00159	0,095
	35,8	30,7	41,7	-	1	0,6	16	30,6	-	46,4	47,8	1	0,6	0,00656	0,095
	39,7	32,3	50,5	56,9	1,1	0,6	26,8	32	39	55	57	1	0,6	0,00391	0,1
	39,7	32,3	48,3	-	1,1	0,6	26,8	32	-	55	57	1	0,6	0,00391	0,1
	39,7	32,3	48,3	-	1,1	0,6	26,8	32	-	55	57	1	0,6	0,00391	0,1
	39,7	32,3	48,3	-	1,1	0,6	26,8	32	-	55	57	1	0,6	0,00391	0,1
	39,7	32,3	48,3	-	1,1	0,6	26,8	32	-	55	57	1	0,6	0,00391	0,1
	39,7	32,3	48,3	-	1,1	0,6	26,8	32	-	55	57	1	0,6	0,00391	0,1
	39,7	32,3	48,3	-	1,1	0,6	26,8	32	-	55	57	1	0,6	0,00391	0,1
39,5	32,2	48,1	-	1,1	0,6	18	32	-	55	57	1	0,6	0,00158	0,1	
30	42,6	36,1	51,8	57,6	1	0,6	27,3	35,6	42	56	57	1	0,6	0,00377	0,095
	42,6	36,1	50,1	-	1	0,6	27,3	35,6	-	56	57	1	0,6	0,00377	0,095
	42,6	36,1	50,1	-	1	0,6	27,3	35,6	-	56	57	1	0,6	0,00377	0,095
	42,6	36,1	50,1	-	1	0,6	27,3	35,6	-	56	57	1	0,6	0,00377	0,095
	42,6	36,1	50,1	-	1	0,6	27,3	35,6	-	56	57	1	0,6	0,00408	0,095
	42,4	35,9	50,1	-	1	0,6	18	35,6	-	56	57	1	0,6	0,00155	0,095
	46,5	37,9	58,8	66,45	1,1	0,6	31	37	46	65	67	1	0,6	0,0074	0,1
	46,5	37,9	56,6	-	1,1	0,6	31	37	-	65	67	1	0,6	0,0074	0,1
	46,5	37,9	56,6	-	1,1	0,6	31	37	-	65	67	1	0,6	0,0074	0,1
	46,5	37,9	56,6	-	1,1	0,6	31	37	-	65	67	1	0,6	0,0074	0,1
	46,5	37,9	56,6	-	1,1	0,6	31	37	-	65	67	1	0,6	0,0074	0,1
	46,5	37,9	56,6	-	1,1	0,6	31	37	-	65	67	1	0,6	0,00814	0,1
	46,3	37,8	56,4	-	1,1	0,6	21	37	-	65	67	1	0,6	0,003	0,1

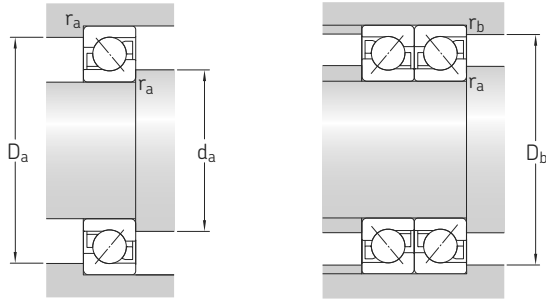
3.1 Single row angular contact ball bearings d 35 – 40 mm



2RZ

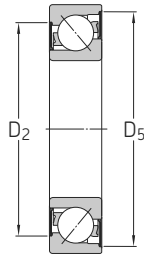
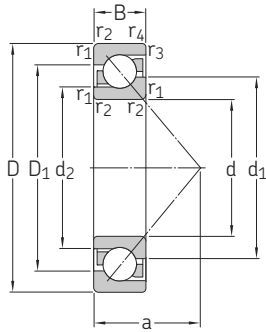


Principal dimensions			Basic load ratings		Fatigue load limit	Speed ratings		Mass	Designations Universally matchable bearing	Basic design / sealed bearing
d	D	B	C	C ₀		Reference speed	Limiting speed			
mm			kN		kN	r/min	kg	–		
35	72	17	29,1	19	0,815	11 000	9 000	0,35	–	▶ 7207 BE-2RZP
	72	17	29,1	19	0,815	11 000	11 000	0,28	–	▶ 7207 BEP
	72	17	31	20,8	0,88	11 000	12 000	0,28	▶ 7207 BECBP	–
	72	17	31	20,8	0,88	11 000	15 000	0,28	▶ 7207 BECBM	–
	72	17	32,5	22,4	0,95	11 000	12 000	0,28	▶ 7207 BECBY	–
	72	17	35,5	23,2	0,98	12 000	18 000	0,28	7207 ACCBM	–
	80	21	39	24,5	1,04	11 000	8 500	0,45	–	▶ 7307 BE-2RZP
	80	21	39	24,5	1,04	11 000	10 000	0,45	–	▶ 7307 BEP
	80	21	41,5	26,5	1,14	11 000	11 000	0,45	▶ 7307 BECBP	–
	80	21	41,5	26,5	1,14	11 000	11 000	0,45	▶ 7307 BECBY	–
	80	21	41,5	26,5	1,14	11 000	11 000	0,45	7307 BEGAPH	–
	80	21	41,5	26,5	1,14	11 000	14 000	0,45	▶ 7307 BECBM	–
80	21	46,5	30	1,27	11 000	17 000	0,45	▶ 7307 ACCBM	–	
40	80	18	34,5	24	1,02	10 000	8 000	0,42	–	▶ 7208 BE-2RZP
	80	18	34,5	24	1,02	10 000	10 000	0,37	–	▶ 7208 BEP
	80	18	36,5	26	1,1	10 000	11 000	0,37	▶ 7208 BECBP	–
	80	18	36,5	26	1,1	10 000	11 000	0,37	7208 BECBPH	–
	80	18	36,5	26	1,1	10 000	13 000	0,37	▶ 7208 BECBM	–
	80	18	39	28	1,2	10 000	11 000	0,37	▶ 7208 BECBY	–
	80	18	41,5	29	1,25	11 000	16 000	0,37	7208 ACCBM	–
	90	23	46,2	30,5	1,29	9 500	7 500	0,62	–	▶ 7308 BE-2RZP
	90	23	46,2	30,5	1,29	9 500	9 000	0,62	–	▶ 7308 BEP
	90	23	50	32,5	1,37	9 500	10 000	0,62	▶ 7308 BECBP	–
	90	23	50	32,5	1,37	9 500	10 000	0,62	7308 BEGAPH	–
	90	23	50	32,5	1,37	9 500	12 000	0,68	▶ 7308 BECBM	–
90	23	53	35,5	1,5	9 500	10 000	0,64	▶ 7308 BECBY	–	
90	23	56	36	1,53	10 000	15 000	0,68	▶ 7308 ACCBM	–	



Dimensions								Abutment and fillet dimensions						Calculation factors	
d	d ₁ ≈	d ₂ ≈	D ₁ , D ₂ ≈	D ₅ ≈	r _{1,2} min.	r _{3,4} min.	a	d _a min.	d _a max.	D _a max.	D _b max.	r _a max.	r _b max.	A	k _r
mm								mm						-	
35	49,6	41,9	59,9	67,7	1,1	0,6	31	42	49	65	67	1	0,6	0,00674	0,095
	49,6	41,9	58,3	-	1,1	0,6	31	42	-	65	67	1	0,6	0,00674	0,095
	49,6	41,9	58,3	-	1,1	0,6	31	42	-	65	67	1	0,6	0,00674	0,095
	49,6	41,9	58,3	-	1,1	0,6	31	42	-	65	67	1	0,6	0,0073	0,095
	49,4	41,9	58,3	-	1,1	0,6	20	42	-	65	67	1	0,6	0,00277	0,095
	52,5	43,6	65,1	74,3	1,5	1	35	44	52	71	74	1,5	1	0,0111	0,1
	52,5	43,6	63,5	-	1,5	1	35	44	-	71	74	1,5	1	0,0111	0,1
	52,5	43,6	63,5	-	1,5	1	35	44	-	71	74	1,5	1	0,0111	0,1
	52,5	43,6	63,5	-	1,5	1	35	44	-	71	74	1,5	1	0,0111	0,1
	52,5	43,6	63,5	-	1,5	1	35	44	-	71	74	1,5	1	0,0111	0,1
	52,5	43,6	63,5	-	1,5	1	35	44	-	71	74	1,5	1	0,0111	0,1
	52,5	43,5	63,2	-	1,5	1	23	44	-	71	74	1,5	1	0,00453	0,1
40	56,2	48	67,2	75,3	1,1	0,6	34	47	55	73	75	1	0,6	0,0102	0,095
	56,2	48	65,6	-	1,1	0,6	34	47	-	73	75	1	0,6	0,0102	0,095
	56,2	48	65,6	-	1,1	0,6	34	47	-	73	75	1	0,6	0,0102	0,095
	56,2	48	65,6	-	1,1	0,6	34	47	-	73	75	1	0,6	0,0102	0,095
	56,2	48	65,6	-	1,1	0,6	34	47	-	73	75	1	0,6	0,0109	0,095
	56	48	65,5	-	1,1	0,6	23	47	-	73	75	1	0,6	0,00419	0,095
	59,7	49,5	73,9	83	1,5	1	39	49	59	81	84	1,5	1	0,0173	0,1
	59,7	49,5	71,6	-	1,5	1	39	49	-	81	84	1,5	1	0,0173	0,1
	59,7	49,5	71,6	-	1,5	1	39	49	-	81	84	1,5	1	0,0173	0,1
	59,7	49,5	71,6	-	1,5	1	39	49	-	81	84	1,5	1	0,0173	0,1
	59,5	49,5	71,6	-	1,5	1	39	49	-	81	84	1,5	1	0,0173	0,1
	59,5	49,5	71,6	-	1,5	1	39	49	-	81	84	1,5	1	0,0189	0,1
	59,7	49,5	71,4	-	1,5	1	26	49	-	81	84	1,5	1	0,00707	0,1

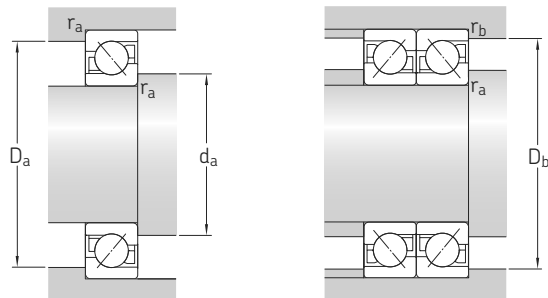
3.1 Single row angular contact ball bearings d 45 – 50 mm



2RZ

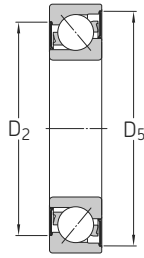
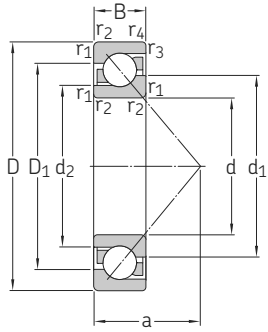
3.1

Principal dimensions			Basic load ratings		Fatigue load limit	Speed ratings		Mass	Designations Universally matchable bearing	Basic design / sealed bearing
d	D	B	C	C ₀		Reference speed	Limiting speed			
mm			kN		kN	r/min	kg	-		
45	85	19	35,8	26	1,12	9 500	7 500	0,52	-	▶ 7209 BE-2RZP
	85	19	38	28,5	1,22	9 500	10 000	0,42	▶ 7209 BECBP	-
	85	19	38	28,5	1,22	9 500	10 000	0,42	▶ 7209 BEGAPH	-
	85	19	38	28,5	1,22	9 500	12 000	0,42	▶ 7209 BECBM	-
	85	19	40	30,5	1,29	9 500	10 000	0,42	▶ 7209 BECBY	-
	85	19	44	32	1,37	10 000	15 000	0,42	▶ 7209 ACCBM	-
	100	25	55,9	37,5	1,6	8 500	6 700	0,85	-	▶ 7309 BE-2RZP
	100	25	55,9	37,5	1,6	8 500	8 000	0,82	-	▶ 7309 BEP
	100	25	61	40,5	1,73	8 500	9 000	0,82	▶ 7309 BECBP	-
	100	25	61	40,5	1,73	8 500	9 000	0,82	7309 BEGAPH	-
	100	25	61	40,5	1,73	8 500	11 000	0,91	▶ 7309 BECBM	-
	100	25	64	45	1,9	8 500	9 000	0,87	▶ 7309 BECBY	-
100	25	68	45,5	1,93	9 000	13 000	0,91	7309 ACCBM	-	
50	90	20	37,7	28,5	1,22	9 000	7 000	0,55	-	▶ 7210 BE-2RZP
	90	20	37,7	28,5	1,22	9 000	8 500	0,47	-	▶ 7210 BEP
	90	20	40	31	1,32	9 000	9 000	0,47	▶ 7210 BECBP	-
	90	20	40	31	1,32	9 000	9 000	0,47	7210 BECBPH	-
	90	20	40	31	1,32	9 000	11 000	0,47	▶ 7210 BECBM	-
	90	20	41,5	33,5	1,4	9 000	9 000	0,47	▶ 7210 BECBY	-
	90	20	45,5	35,5	1,5	9 500	14 000	0,47	7210 ACCBM	-
	110	27	68,9	47,5	2	7 500	6 000	1,2	-	▶ 7310 BE-2RZP
	110	27	75	51	2,16	7 500	8 000	1,1	▶ 7310 BECBP	-
	110	27	75	51	2,16	7 500	8 000	1,1	▶ 7310 BEGAPH	-
	110	27	75	51	2,16	7 500	10 000	1,1	▶ 7310 BECBM	-
	110	27	78	56	2,36	7 500	8 000	1,15	▶ 7310 BECBY	-
110	27	83	57	2,4	8 000	12 000	1,1	7310 ACCBM	-	



Dimensions								Abutment and fillet dimensions						Calculation factors	
d	d ₁ ≈	d ₂ ≈	D ₁ , D ₂ ≈	D ₅ ≈	r _{1,2} min.	r _{3,4} min.	a	d _a min.	d _a max.	D _a max.	D _b max.	r _a max.	r _b max.	A	k _r
mm								mm						-	
45	60,8	52,6	71,8	79,9	1,1	0,6	37	52	60	78	80	1	0,6	0,012	0,095
	60,8	52,6	70,2	-	1,1	0,6	37	52	-	78	80	1	0,6	0,012	0,095
	60,8	52,6	70,2	-	1,1	0,6	37	52	-	78	80	1	0,6	0,012	0,095
	60,8	52,6	70,2	-	1,1	0,6	37	52	-	78	80	1	0,6	0,0128	0,095
	60,6	52,6	70,1	-	1,1	0,6	24	52	-	78	80	1	0,6	0,00496	0,095
	66,5	55,2	81,4	90,8	1,5	1	43	54	66	91	94	1,5	1	0,0268	0,1
	66,5	55,2	79,9	-	1,5	1	43	54	-	91	94	1,5	1	0,0268	0,1
	66,5	55,2	79,9	-	1,5	1	43	54	-	91	94	1,5	1	0,0268	0,1
	66,5	55,2	79,9	-	1,5	1	43	54	-	91	94	1,5	1	0,0268	0,1
	66,5	55,2	79,9	-	1,5	1	43	54	-	91	94	1,5	1	0,0292	0,1
	66,3	55,2	79,6	-	1,5	1	29	54	-	91	94	1,5	1	0,0109	0,1
	50	65,7	57,6	76,8	84,9	1,1	0,6	39	57	65	83	85	1	0,6	0,014
65,7		57,6	75,2	-	1,1	0,6	39	57	-	83	85	1	0,6	0,014	0,095
65,7		57,6	75,2	-	1,1	0,6	39	57	-	83	85	1	0,6	0,014	0,095
65,7		57,6	75,2	-	1,1	0,6	39	57	-	83	85	1	0,6	0,014	0,095
65,7		57,6	75,2	-	1,1	0,6	39	57	-	83	85	1	0,6	0,015	0,095
65,6		57,6	75,1	-	1,1	0,6	26	57	-	83	85	1	0,6	0,00584	0,095
73,8		61,1	91,6	101	2	1	47	61	73	99	104	2	1	0,0418	0,1
73,8		61,1	88,8	-	2	1	47	61	-	99	104	2	1	0,0418	0,1
73,8		61,1	88,8	-	2	1	47	61	-	99	104	2	1	0,0418	0,1
73,8		61,1	88,8	-	2	1	47	61	-	99	104	2	1	0,0418	0,1
73,8		61,1	88,8	-	2	1	47	61	-	99	104	2	1	0,0456	0,1
73,6		61,1	88,4	-	2	1	32	61	-	99	104	2	1	0,017	0,1

3.1 Single row angular contact ball bearings d 55 – 60 mm

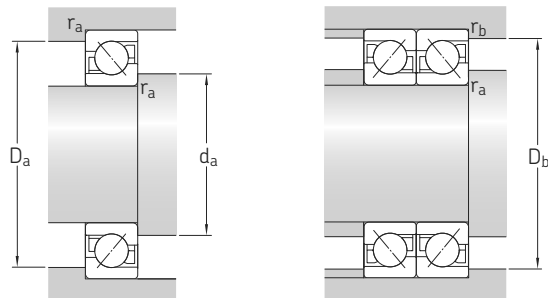


2RZ

3.1

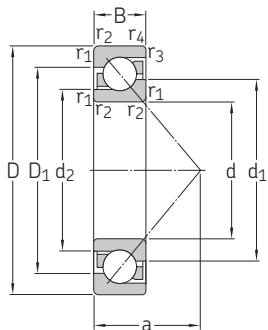


Principal dimensions			Basic load ratings		Fatigue load limit	Speed ratings		Mass	Designations	Basic design / sealed bearing
d	D	B	C	C ₀		Reference speed	Limiting speed			
mm			kN		kN	r/min		kg	–	
55	100	21	46,2	36	1,53	8 000	6 300	0,62	–	▶ 7211 BE-2RZP
	100	21	46,2	36	1,53	8 000	7 500	0,62	–	▶ 7211 BEP
	100	21	49	40	1,66	8 000	8 000	0,62	▶ 7211 BECBP	–
	100	21	49	40	1,66	8 000	8 000	0,62	7211 BECBPH	–
	100	21	49	40	1,66	8 000	10 000	0,62	▶ 7211 BECBM	–
	100	21	51	42,5	1,8	8 000	8 000	0,62	▶ 7211 BECBy	–
	100	21	57	45	1,9	8 500	12 000	0,62	7211 ACCBM	–
	120	29	79,3	55	2,32	7 000	6 700	1,4	–	▶ 7311 BEP
	120	29	85	60	2,55	7 000	7 000	1,4	▶ 7311 BECBP	–
	120	29	85	60	2,55	7 000	7 000	1,4	7311 BECBPH	–
	120	29	85	60	2,55	7 000	9 000	1,4	▶ 7311 BECBM	–
	120	29	90	65,5	2,75	7 000	7 000	1,4	▶ 7311 BECBy	–
120	29	96,5	67	2,85	7 500	11 000	1,4	7311 ACCBM	–	
60	110	22	57,2	45,5	1,93	7 000	7 000	0,8	–	▶ 7212 BEP
	110	22	61	50	2,12	7 000	7 500	0,8	▶ 7212 BECBP	–
	110	22	61	50	2,12	7 000	7 500	0,8	7212 BECBPH	–
	110	22	61	50	2,12	7 000	7 500	0,8	▶ 7212 BECBy	–
	110	22	61	50	2,12	7 000	9 500	0,8	▶ 7212 BECBM	–
	110	22	69,5	56	2,36	8 000	11 000	0,8	7212 ACCBM	–
	130	31	95,6	69,5	3	6 300	6 000	1,75	–	▶ 7312 BEP
	130	31	104	76,5	3,2	6 300	6 700	1,75	▶ 7312 BECBP	–
	130	31	104	76,5	3,2	6 300	6 700	1,75	7312 BECBPH	–
	130	31	104	76,5	3,2	6 300	6 700	1,75	▶ 7312 BECBy	–
	130	31	104	76,5	3,2	6 300	8 500	1,75	▶ 7312 BECBM	–
	130	31	116	85	3,6	7 000	10 000	1,75	7312 ACCBM	–



Dimensions								Abutment and fillet dimensions						Calculation factors	
d	d ₁ ≈	d ₂ ≈	D ₁ , D ₂ ≈	D ₅ ≈	r _{1,2} min.	r _{3,4} min.	a	d _a min.	d _a max.	D _a max.	D _b max.	r _a max.	r _b max.	A	k _r
mm								mm						-	
55	72,5	63,6	85,1	94,3	1,5	1	43	64	72	91	94	1,5	1	0,022	0,095
	72,5	63,6	83,7	-	1,5	1	43	64	-	91	94	1,5	1	0,022	0,095
	72,4	63,6	83,7	-	1,5	1	43	64	-	91	94	1,5	1	0,022	0,095
	72,4	63,6	83,7	-	1,5	1	43	64	-	91	94	1,5	1	0,022	0,095
	72,4	63,6	83,7	-	1,5	1	43	64	-	91	94	1,5	1	0,0235	0,095
	72,6	63,6	83,2	-	1,5	1	28	64	-	91	94	1,5	1	0,00917	0,095
	80,3	66,6	96,6	-	2	1	51	66	-	109	114	2	1	0,0574	0,1
	80,3	66,6	96,6	-	2	1	51	66	-	109	114	2	1	0,0574	0,1
	80,3	66,6	96,6	-	2	1	51	66	-	109	114	2	1	0,0574	0,1
	80,3	66,6	96,6	-	2	1	51	66	-	109	114	2	1	0,0627	0,1
	80,1	66,6	96,2	-	2	1	34	66	-	109	114	2	1	0,0234	0,1
	60	79,6	69,3	91,6	-	1,5	1	47	69	-	101	104	1,5	1	0,0344
79,6		69,3	91,6	-	1,5	1	47	69	-	101	104	1,5	1	0,0344	0,095
79,6		69,3	91,6	-	1,5	1	47	69	-	101	104	1,5	1	0,0344	0,095
79,6		69,3	91,6	-	1,5	1	47	69	-	101	104	1,5	1	0,0344	0,095
79,6		69,3	91,6	-	1,5	1	46	69	-	101	104	1,5	1	0,0344	0,095
79,5		69,2	91,5	-	1,5	1	30	69	-	101	104	1,5	1	0,0143	0,095
87,2		72,6	105	-	2,1	1,1	55	72	-	118	123	2	1	0,0846	0,1
87,2		72,6	105	-	2,1	1,1	55	72	-	118	123	2	1	0,0846	0,1
87,2		72,6	105	-	2,1	1,1	55	72	-	118	123	2	1	0,0846	0,1
87,2		72,6	105	-	2,1	1,1	55	72	-	118	123	2	1	0,0846	0,1
87,2		72,6	105	-	2,1	1,1	55	72	-	118	123	2	1	0,0846	0,1
87,1		72,6	105	-	2,1	1,1	37	72	-	118	123	2	1	0,0345	0,1

3.1 Single row angular contact ball bearings d 65 – 75 mm

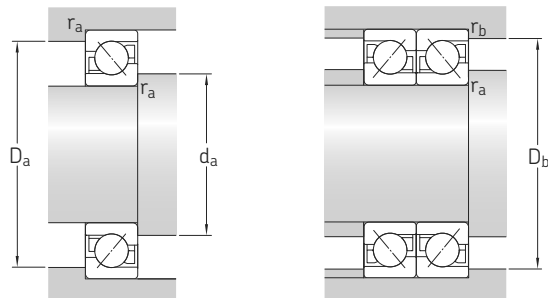


3.1



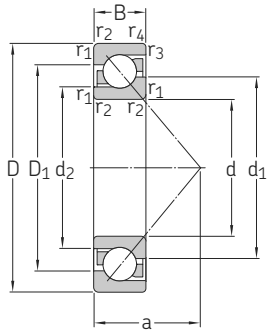
Principal dimensions			Basic load ratings		Fatigue load limit	Speed ratings		Mass	Designations Universally matchable bearing	Basic design / sealed bearing
d	D	B	C	C ₀		Reference speed	Limiting speed			
mm			kN		kN	r/min	kg	–		
65	120	23	66,3	54	2,28	6 700	6 300	1	–	▶ 7213 BEP
	120	23	69,5	57	2,45	6 700	6 700	1	▶ 7213 BECBP	–
	120	23	69,5	57	2,45	6 700	6 700	1	▶ 7213 BECBy	–
	120	23	69,5	57	2,45	6 700	6 700	1	7213 BEGAPH	–
	120	23	69,5	57	2,45	6 700	8 500	1	▶ 7213 BECBM	–
	120	23	81,5	65,5	2,8	7 000	10 000	1	7213 ACCBM	–
	140	33	108	80	3,35	6 000	5 600	2,15	–	▶ 7313 BEP
	140	33	116	86,5	3,65	6 000	6 300	2,15	▶ 7313 BECBP	–
	140	33	116	86,5	3,65	6 000	6 300	2,15	7313 BECBPH	–
	140	33	116	86,5	3,65	6 000	6 300	2,15	▶ 7313 BECBy	–
	140	33	116	86,5	3,65	6 000	8 000	2,15	▶ 7313 BECBM	–
	140	33	132	96,5	4,05	6 300	9 500	2,15	7313 ACCBM	–
70	125	24	67,6	56	2,36	6 300	6 000	1,1	–	▶ 7214 BEP
	125	24	72	60	2,55	6 300	6 300	1,1	▶ 7214 BECBP	–
	125	24	72	60	2,55	6 300	6 300	1,1	7214 BECBPH	–
	125	24	72	60	2,55	6 300	8 000	1,1	▶ 7214 BECBM	–
	125	24	75	64	2,7	6 300	6 300	1,1	▶ 7214 BECBy	–
	125	24	83	68	2,9	6 700	10 000	1,1	7214 ACCBM	–
	150	35	119	90	3,65	5 600	5 300	2,65	–	▶ 7314 BEP
	150	35	127	98	3,9	5 600	5 600	2,65	▶ 7314 BECBP	–
	150	35	127	98	3,9	5 600	5 600	2,65	▶ 7314 BECBPH	–
	150	35	127	98	3,9	5 600	5 600	2,65	▶ 7314 BECBy	–
	150	35	127	98	3,9	5 600	5 600	2,65	7314 BEGAPH	–
	150	35	127	98	3,9	5 600	7 000	2,65	▶ 7314 BECBM	–
150	35	143	110	4,4	6 000	8 500	2,65	7314 ACCBM	–	
75	130	25	70,2	60	2,5	6 000	5 600	1,2	–	▶ 7215 BEP
	130	25	73,5	65,5	2,7	6 000	6 300	1,2	▶ 7215 BECBM	–
	130	25	73,5	65,5	2,7	6 000	6 300	1,2	▶ 7215 BECBP	–
	130	25	73,5	65,5	2,7	6 000	6 300	1,2	7215 BECBPH	–
	130	25	76,5	69,5	2,9	6 000	6 300	1,2	▶ 7215 BECBy	–
	160	37	125	98	3,8	5 300	5 000	3,2	–	▶ 7315 BEP
	160	37	132	104	4,15	5 300	5 300	3,2	▶ 7315 BECBP	–
	160	37	132	104	4,15	5 300	5 300	3,2	▶ 7315 BECBy	–
	160	37	132	104	4,15	5 300	5 300	3,2	7315 BEGAPH	–
	160	37	132	104	4,15	5 300	5 300	3,2	▶ 7315 BECBM	–
	160	37	132	104	4,15	5 300	6 700	3,2	▶ 7315 BECBM	–

SKF Explorer bearing
▶ Popular item



Dimensions								Abutment and fillet dimensions						Calculation factors	
d	d ₁ ≈	d ₂ ≈	D ₁ , D ₂ ≈	D ₅ ≈	r _{1,2} min.	r _{3,4} min.	a	d _a min.	d _a max.	D _a max.	D _b max.	r _a max.	r _b max.	A	k _r
mm								mm						-	
65	86,3	75,4	100	-	1,5	1	50	74	-	111	114	1,5	1	0,0478	0,095
	86,3	75,4	99,5	-	1,5	1	50	74	-	111	114	1,5	1	0,0478	0,095
	86,3	75,4	99,5	-	1,5	1	50	74	-	111	114	1,5	1	0,0478	0,095
	86,3	75,4	100	-	1,5	1	50	74	-	111	114	1,5	1	0,0478	0,095
	86,3	75,4	99,5	-	1,5	1	50	74	-	111	114	1,5	1	0,0478	0,095
	86,5	75,5	99,5	-	1,5	1	33	74	-	111	114	1,5	1	0,0199	0,095
	94,1	78,4	113	-	2,1	1,1	60	77	-	128	133	2	1	0,112	0,1
	94,1	78,4	113	-	2,1	1,1	60	77	-	128	133	2	1	0,112	0,1
	94,1	78,4	113	-	2,1	1,1	60	77	-	128	133	2	1	0,112	0,1
	94,1	78,4	113	-	2,1	1,1	60	77	-	128	133	2	1	0,112	0,1
	94,1	78,4	113	-	2,1	1,1	60	77	-	128	133	2	1	0,112	0,1
	94	78,4	113	-	2,1	1,1	40	77	-	128	133	2	1	0,0456	0,1
70	91,5	80,2	105	-	1,5	1	53	79	-	116	119	1,5	1	0,0529	0,095
	91,5	80,2	105	-	1,5	1	53	79	-	116	119	1,5	1	0,0529	0,095
	91,5	80,2	105	-	1,5	1	53	79	-	116	119	1,5	1	0,0529	0,095
	91,5	80,2	105	-	1,5	1	53	79	-	116	119	1,5	1	0,0529	0,095
	91,5	80,2	105	-	1,5	1	53	79	-	116	119	1,5	1	0,0564	0,095
	91,4	80,2	105	-	1,5	1	34	79	-	116	119	1,5	1	0,022	0,095
	101	84,4	122	-	2,1	1,1	64	82	-	138	143	2	1	0,145	0,1
	101	84,4	122	-	2,1	1,1	64	82	-	138	143	2	1	0,145	0,1
	101	84,4	122	-	2,1	1,1	64	82	-	138	143	2	1	0,145	0,1
	101	84,4	122	-	2,1	1,1	64	82	-	138	143	2	1	0,145	0,1
	101	84,4	122	-	2,1	1,1	64	82	-	138	143	2	1	0,145	0,1
	100	84,4	121	-	2,1	1,1	43	82	-	138	143	2	1	0,0592	0,1
75	96,3	85,2	111	-	1,5	1	56	84	-	121	124	1,5	1	0,0599	0,095
	96,3	85,2	111	-	1,5	1	56	84	-	121	124	1,5	1	0,0599	0,095
	96,3	85,2	111	-	1,5	1	56	84	-	121	124	1,5	1	0,0599	0,095
	96,3	85,2	111	-	1,5	1	56	84	-	121	124	1,5	1	0,0599	0,095
	96,3	85,2	111	-	1,5	1	56	84	-	121	124	1,5	1	0,0599	0,095
	108	91,1	129	-	2,1	1,1	68	87	-	148	153	2	1	0,171	0,1
	108	91,1	129	-	2,1	1,1	68	87	-	148	153	2	1	0,171	0,1
	108	91,1	129	-	2,1	1,1	68	87	-	148	153	2	1	0,171	0,1
	108	91,1	129	-	2,1	1,1	68	87	-	148	153	2	1	0,171	0,1
	108	91,1	129	-	2,1	1,1	68	87	-	148	153	2	1	0,171	0,1
	108	91,1	129	-	2,1	1,1	68	87	-	148	153	2	1	0,171	0,1
	108	91,1	129	-	2,1	1,1	68	87	-	148	153	2	1	0,171	0,1

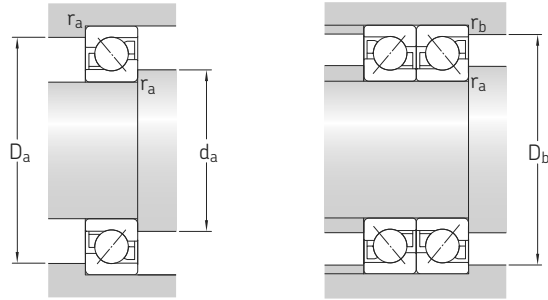
3.1 Single row angular contact ball bearings d 80 – 90 mm



3.1

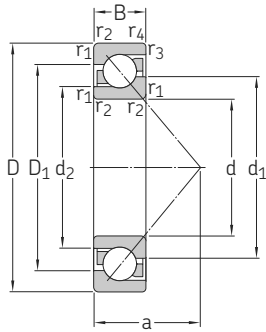


Principal dimensions			Basic load ratings		Fatigue load limit	Speed ratings		Mass	Designations Universally matchable bearing	Basic design / sealed bearing	
d	D	B	C	C ₀		Reference speed	Limiting speed				
mm			kN		kN	r/min		kg	–		
80	140	26	80,6	69,5	2,8	5 600	5 300	1,45	–	▶ 7216 BEP	
	140	26	85	75	3,05	5 600	5 600	1,45	▶ 7216 BECBP	–	
	140	26	85	75	3,05	5 600	5 600	1,45	▶ 7216 BECBPH	–	
	140	26	85	75	3,05	5 600	5 600	1,45	▶ 7216 BECBBY	–	
	140	26	85	75	3,05	5 600	5 600	1,45	▶ 7216 BEGAPH	–	
	140	26	85	75	3,05	5 600	7 000	1,45	▶ 7216 BECBM	–	
	170	39	135	110	4,15	5 000	4 500	3,8	–	▶ 7316 BEP	
	170	39	135	110	4,15	5 000	4 800	3,8	–	▶ 7316 BEM	
	170	39	143	118	4,5	5 000	5 000	3,8	▶ 7316 BECBP	–	
	170	39	143	118	4,5	5 000	5 000	3,8	▶ 7316 BECBPH	–	
	170	39	143	118	4,5	5 000	5 000	3,8	▶ 7316 BECBBY	–	
	170	39	143	118	4,5	5 000	6 300	3,8	▶ 7316 BECBM	–	
85	150	28	95,6	83	3,25	5 300	5 000	1,85	–	▶ 7217 BEP	
	150	28	102	90	3,55	5 300	5 300	1,85	▶ 7217 BECBP	–	
	150	28	102	90	3,55	5 300	5 300	1,85	▶ 7217 BECBBY	–	
	150	28	102	90	3,55	5 300	6 700	1,85	▶ 7217 BECBM	–	
	180	41	146	122	4,5	4 500	4 300	4,45	–	▶ 7317 BEP	
	180	41	146	122	4,5	4 500	4 500	4,45	–	▶ 7317 BEM	
	180	41	156	132	4,9	4 500	4 800	4,45	▶ 7317 BECBP	–	
	180	41	156	132	4,9	4 500	4 800	4,45	▶ 7317 BECBBY	–	
	180	41	156	132	4,9	4 500	4 800	4,45	▶ 7317 BEGAPH	–	
	180	41	156	132	4,9	4 500	6 000	4,45	▶ 7317 BECBM	–	
	90	160	30	108	96,5	3,65	5 000	4 500	2,3	–	▶ 7218 BEP
		160	30	116	104	4	5 000	5 000	2,3	▶ 7218 BECBP	–
160		30	116	104	4	5 000	5 000	2,3	▶ 7218 BECBBY	–	
160		30	116	104	4	5 000	6 300	2,3	▶ 7218 BECBM	–	
190		43	156	134	4,8	4 300	4 000	5,2	–	▶ 7318 BEP	
190		43	156	134	4,8	4 300	4 300	5,2	–	▶ 7318 BEM	
190		43	166	146	5,3	4 300	4 500	5,2	▶ 7318 BECBP	–	
190		43	166	146	5,3	4 300	4 500	5,2	▶ 7318 BECBBY	–	
190		43	166	146	5,3	4 300	4 500	5,2	▶ 7318 BEGAPH	–	
190		43	166	146	5,3	4 300	5 600	5,2	▶ 7318 BECBM	–	



Dimensions								Abutment and fillet dimensions						Calculation factors	
d	d ₁ ≈	d ₂ ≈	D ₁ , D ₂ ≈	D ₅ ≈	r _{1,2} min.	r _{3,4} min.	a	d _a min.	d _a max.	D _a max.	D _b max.	r _a max.	r _b max.	A	k _r
mm								mm						-	
80	103	91,4	118	-	2	1	59	91	-	130	134	2	1	0,0801	0,095
	103	91,4	118	-	2	1	59	91	-	130	134	2	1	0,0801	0,095
	103	91,4	118	-	2	1	59	91	-	130	134	2	1	0,0801	0,095
	103	91,4	118	-	2	1	59	91	-	130	134	2	1	0,0801	0,095
	103	91,4	118	-	2	1	59	91	-	130	134	2	1	0,0801	0,095
	115	97	137	-	2,1	1,1	72	92	-	158	163	2	1	0,216	0,1
	115	97	137	-	2,1	1,1	72	92	-	158	163	2	1	0,216	0,1
	115	97	137	-	2,1	1,1	72	92	-	158	163	2	1	0,216	0,1
	115	97	137	-	2,1	1,1	72	92	-	158	163	2	1	0,216	0,1
	115	97	137	-	2,1	1,1	72	92	-	158	163	2	1	0,216	0,1
	115	97	137	-	2,1	1,1	72	92	-	158	163	2	1	0,216	0,1
	115	97	137	-	2,1	1,1	72	92	-	158	163	2	1	0,216	0,1
85	110	97	127	-	2	1	63	96	-	139	144	2	1	0,114	0,095
	110	97	127	-	2	1	63	96	-	139	144	2	1	0,114	0,095
	110	97	127	-	2	1	63	96	-	139	144	2	1	0,114	0,095
	110	97	127	-	2	1	63	96	-	139	144	2	1	0,114	0,095
	122	103	145	-	3	1,1	76	99	-	166	173	2,5	1	0,27	0,1
	122	103	145	-	3	1,1	76	99	-	166	173	2,5	1	0,27	0,1
	122	103	145	-	3	1,1	76	99	-	166	173	2,5	1	0,27	0,1
	122	103	145	-	3	1,1	76	99	-	166	173	2,5	1	0,27	0,1
	122	103	145	-	3	1,1	76	99	-	166	173	2,5	1	0,27	0,1
	122	103	145	-	3	1,1	76	99	-	166	173	2,5	1	0,27	0,1
	122	103	145	-	3	1,1	76	99	-	166	173	2,5	1	0,27	0,1
	122	103	145	-	3	1,1	76	99	-	166	173	2,5	1	0,27	0,1
90	117	103	135	-	2	1	67	101	-	149	154	2	1	0,149	0,095
	117	103	135	-	2	1	67	101	-	149	154	2	1	0,149	0,095
	117	103	135	-	2	1	67	101	-	149	154	2	1	0,149	0,095
	117	103	135	-	2	1	67	101	-	149	154	2	1	0,149	0,095
	129	108	154	-	3	1,1	80	104	-	176	183	2,5	1	0,333	0,1
	129	108	154	-	3	1,1	80	104	-	176	183	2,5	1	0,333	0,1
	129	108	154	-	3	1,1	80	104	-	176	183	2,5	1	0,333	0,1
	129	108	154	-	3	1,1	80	104	-	176	183	2,5	1	0,333	0,1
	129	108	154	-	3	1,1	80	104	-	176	183	2,5	1	0,333	0,1
	129	108	154	-	3	1,1	80	104	-	176	183	2,5	1	0,333	0,1
	129	108	154	-	3	1,1	80	104	-	176	183	2,5	1	0,333	0,1
	129	108	154	-	3	1,1	80	104	-	176	183	2,5	1	0,333	0,1

3.1 Single row angular contact ball bearings d 95 – 110 mm

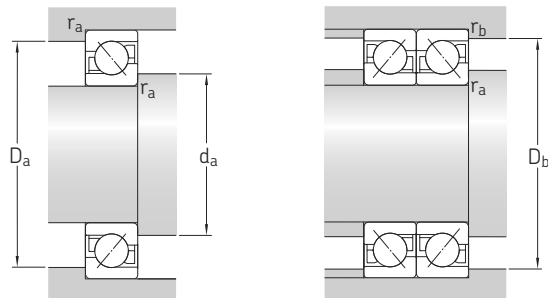


3.1



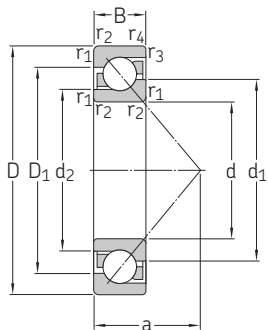
Principal dimensions			Basic load ratings		Fatigue load limit	Speed ratings		Mass	Designations Universally matchable bearing	Basic design / sealed bearing
d	D	B	C	C ₀		Reference speed	Limiting speed			
mm			kN		kN	r/min	kg	–		
95	170	32	124	108	4	4 500	4 300	2,7	–	▶ 7219 BEP
	170	32	129	118	4,4	4 500	4 800	2,7	▶ 7219 BECBP	–
	170	32	129	118	4,4	4 500	4 800	2,7	▶ 7219 BECBY	–
	170	32	129	118	4,4	4 500	4 800	2,7	7219 BEGAPH	–
	170	32	129	118	4,4	4 500	6 000	2,7	▶ 7219 BECBM	–
	200	45	168	150	5,2	4 000	3 800	6,05	–	▶ 7319 BEP
	200	45	168	150	5,2	4 000	4 000	6,05	–	▶ 7319 BEM
	200	45	180	163	5,7	4 000	4 300	6,05	▶ 7319 BECBP	–
	200	45	180	163	5,7	4 000	4 300	6,05	▶ 7319 BECBY	–
	200	45	180	163	5,7	4 000	5 300	6,05	▶ 7319 BECBM	–
100	180	34	135	122	4,4	4 300	4 000	3,3	–	▶ 7220 BEP
	180	34	143	134	4,75	4 300	4 500	3,3	▶ 7220 BECBP	–
	180	34	143	134	4,75	4 300	4 500	3,3	▶ 7220 BECBY	–
	180	34	143	134	4,75	4 300	5 600	3,3	▶ 7220 BECBM	–
	215	47	203	190	6,4	3 800	3 600	7,5	–	▶ 7320 BEM
	215	47	203	190	6,4	3 800	3 600	7,5	–	▶ 7320 BEP
	215	47	216	208	6,95	3 800	4 000	7,5	▶ 7320 BECBP	–
	215	47	216	208	6,95	3 800	4 000	7,5	▶ 7320 BECBY	–
	215	47	216	208	6,95	3 800	5 000	7,5	▶ 7320 BECBM	–
	105	190	36	156	150	5,2	4 000	4 300	3,95	▶ 7221 BECBP
190		36	156	150	5,2	4 000	5 300	3,95	▶ 7221 BECBM	–
225		49	203	193	6,4	3 600	3 400	8,55	–	▶ 7321 BEP
225		49	216	208	6,95	3 600	3 800	8,55	▶ 7321 BECBP	–
225		49	216	208	6,95	3 600	4 800	8,55	▶ 7321 BECBM	–
110		200	38	153	143	4,9	4 000	3 600	4,6	–
	200	38	163	156	5,3	4 000	4 000	4,6	▶ 7222 BECBP	–
	200	38	163	156	5,3	4 000	4 000	4,6	▶ 7222 BECBY	–
	200	38	163	156	5,3	4 000	5 000	4,6	▶ 7222 BECBM	–
	240	50	225	224	7,2	3 400	3 200	10	–	7322 BEY
	240	50	225	224	7,2	3 400	3 400	10	–	▶ 7322 BEM
	240	50	240	245	7,8	3 400	3 600	10	▶ 7322 BECBP	–
	240	50	240	245	7,8	3 400	3 600	10	▶ 7322 BECBY	–
	240	50	240	245	7,8	3 400	4 500	10	▶ 7322 BECBM	–

SKF Explorer bearing
▶ Popular item



Dimensions								Abutment and fillet dimensions						Calculation factors	
d	d ₁ ≈	d ₂ ≈	D ₁ , D ₂ ≈	D ₅ ≈	r _{1,2} min.	r _{3,4} min.	a	d _a min.	d _a max.	D _a max.	D _b max.	r _a max.	r _b max.	A	k _r
mm								mm						-	
95	124	109	143	-	2,1	1,1	72	107	-	158	163	2	1	0,191	0,095
	124	109	143	-	2,1	1,1	72	107	-	158	163	2	1	0,191	0,095
	124	109	143	-	2,1	1,1	72	107	-	158	163	2	1	0,191	0,095
	124	109	143	-	2,1	1,1	72	107	-	158	163	2	1	0,191	0,095
	136	114	162	-	3	1,1	84	109	-	186	193	2,5	1	0,406	0,1
	136	114	162	-	3	1,1	84	109	-	186	193	2,5	1	0,406	0,1
	136	114	162	-	3	1,1	84	109	-	186	193	2,5	1	0,406	0,1
	136	114	162	-	3	1,1	84	109	-	186	193	2,5	1	0,406	0,1
	136	114	162	-	3	1,1	84	109	-	186	193	2,5	1	0,406	0,1
	136	114	162	-	3	1,1	84	109	-	186	193	2,5	1	0,406	0,1
	136	114	162	-	3	1,1	84	109	-	186	193	2,5	1	0,406	0,1
	136	114	162	-	3	1,1	84	109	-	186	193	2,5	1	0,406	0,1
100	130	115	151	-	2,1	1,1	76	112	-	168	173	2	1	0,239	0,095
	130	115	151	-	2,1	1,1	76	112	-	168	173	2	1	0,239	0,095
	130	115	151	-	2,1	1,1	76	112	-	168	173	2	1	0,239	0,095
	130	115	151	-	2,1	1,1	76	112	-	168	173	2	1	0,239	0,095
	144	120	174	-	3	1,1	90	114	-	201	208	2,5	1	0,63	0,1
	144	120	174	-	3	1,1	90	114	-	201	208	2,5	1	0,63	0,1
	144	120	174	-	3	1,1	90	114	-	201	208	2,5	1	0,63	0,1
	144	120	174	-	3	1,1	90	114	-	201	208	2,5	1	0,63	0,1
	144	120	174	-	3	1,1	90	114	-	201	208	2,5	1	0,63	0,1
	144	120	174	-	3	1,1	90	114	-	201	208	2,5	1	0,63	0,1
	144	120	174	-	3	1,1	90	114	-	201	208	2,5	1	0,63	0,1
	144	120	174	-	3	1,1	90	114	-	201	208	2,5	1	0,63	0,1
105	137	121	160	-	2,1	1,1	80	117	-	178	183	2	1	0,302	0,095
	137	121	160	-	2,1	1,1	80	117	-	178	183	2	1	0,302	0,095
	151	127	182	-	3	1,1	94	119	-	211	218	2,5	1	0,669	0,1
	151	127	182	-	3	1,1	94	119	-	211	218	2,5	1	0,669	0,1
	151	127	182	-	3	1,1	94	119	-	211	218	2,5	1	0,669	0,1
	151	127	182	-	3	1,1	94	119	-	211	218	2,5	1	0,669	0,1
110	144	127	168	-	2,1	1,1	84	122	-	188	193	2	1	0,353	0,095
	144	127	168	-	2,1	1,1	84	122	-	188	193	2	1	0,353	0,095
	144	127	168	-	2,1	1,1	84	122	-	188	193	2	1	0,353	0,095
	144	127	168	-	2,1	1,1	84	122	-	188	193	2	1	0,353	0,095
	160	134	194	-	3	1,1	99	124	-	226	233	2,5	1	0,906	0,1
	160	134	194	-	3	1,1	99	124	-	226	233	2,5	1	0,906	0,1
	160	134	194	-	3	1,1	99	124	-	226	233	2,5	1	0,906	0,1
	160	134	194	-	3	1,1	99	124	-	226	233	2,5	1	0,906	0,1
	160	134	194	-	3	1,1	99	124	-	226	233	2,5	1	0,906	0,1
	160	134	194	-	3	1,1	99	124	-	226	233	2,5	1	0,906	0,1
	160	134	194	-	3	1,1	99	124	-	226	233	2,5	1	0,906	0,1
	160	134	194	-	3	1,1	99	124	-	226	233	2,5	1	0,906	0,1

3.1 Single row angular contact ball bearings d 120 – 300 mm

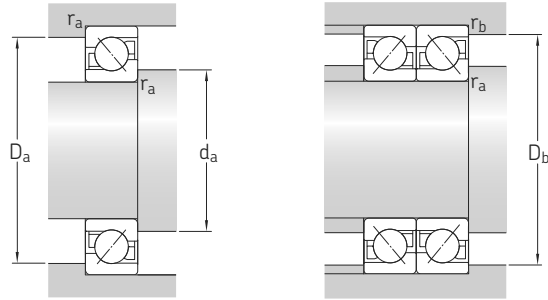


3.1



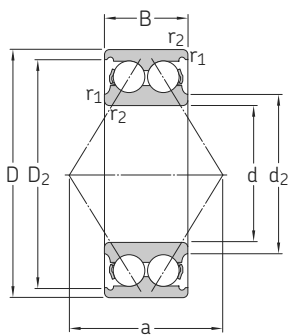
Principal dimensions			Basic load ratings		Fatigue load limit	Speed ratings		Mass	Designations Universally matchable bearing	Basic design / sealed bearing
d	D	B	C	C ₀		Reference speed	Limiting speed			
mm			kN		kN	r/min		kg	–	
120	180	28	87,1	93	3,2	4 000	4 000	2,4	▶ 7024 BGM	–
	215	40	165	163	5,3	3 600	4 000	5,9	▶ 7224 BCBM	▶ 7224 BM
	260	55	238	250	7,65	3 000	3 600	14,5	▶ 7324 BCBM	–
130	230	40	186	193	6,1	3 400	3 800	6,95	▶ 7226 BCBM	▶ 7226 BM
	280	58	276	305	9	2 800	3 400	17	▶ 7326 BCBM	▶ 7326 BM
140	210	33	114	129	4,15	3 400	3 400	3,85	▶ 7028 BGM	–
	250	42	199	212	6,4	3 000	3 600	8,85	▶ 7228 BCBM	▶ 7228 BM
	300	62	302	345	9,8	2 600	3 000	21,5	▶ 7328 BCBM	–
150	225	35	133	146	4,55	3 200	3 200	4,7	7030 BGM	–
	270	45	216	240	6,95	2 800	3 200	11,5	▶ 7230 BCBM	–
	320	65	332	390	10,8	2 400	2 800	26	▶ 7330 BCBM	–
160	290	48	255	300	8,5	2 600	3 000	14	▶ 7232 BCBM	–
	360	72	390	490	12,7	2 200	2 600	36	▶ 7334 BCBM	–
170	260	42	172	204	5,85	2 800	2 800	7,65	7034 BGM	–
	310	52	281	345	9,5	2 400	2 800	17,5	▶ 7234 BCBM	–
	360	72	390	490	12,7	2 200	2 600	36	▶ 7334 BCBM	–
180	280	46	195	240	6,7	2 600	2 600	10	7036 BGM	–
	320	52	291	375	10	2 400	2 600	18	▶ 7236 BCBM	–
	380	75	410	540	13,7	2 000	2 400	42	▶ 7336 BCBM	–
190	290	46	199	255	6,95	2 400	2 400	10,5	7038 BGM	–
	340	55	307	405	10,4	2 000	2 600	22	▶ 7238 BCBM	–
	400	78	442	600	14,6	2 000	2 200	48,5	▶ 7338 BCBM	–
200	310	51	225	290	7,8	2 200	2 200	18	▶ 7040 BGM	–
	360	58	325	430	11	2 000	2 400	25	▶ 7240 BCBM	–
	420	80	462	655	15,6	1 900	2 200	53	7340 BCBM	–
220	340	56	255	355	9	2 000	2 000	18	7044 BGM	–
	400	65	390	560	13,4	1 900	2 200	37	7244 BCBM	–
240	360	56	260	375	9,15	1 900	1 900	19	▶ 7048 BGM	–
	440	72	449	670	15,3	1 600	2 600	49	▶ 7248 BCBM	–
260	400	65	332	510	11,8	1 700	1 700	30	7052 BGM	–
280	420	65	338	540	12,2	1 600	1 600	30	7056 BGM	–
	500	80	507	830	17,6	1 400	1 400	67,5	–	7256 BM
300	540	85	553	930	19,3	1 300	1 300	85	7260 BCBM	–

▶ Popular item

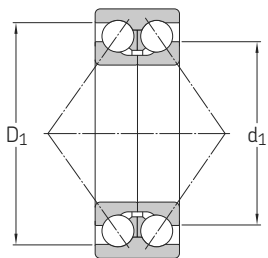


Dimensions								Abutment and fillet dimensions						Calculation factors		
d	d ₁ ≈	d ₂ ≈	D ₁ , D ₂ ≈	D ₅ ≈	r _{1,2} min.	r _{3,4} min.	a	d _a min.	d _a max.	D _a max.	D _b max.	r _a max.	r _b max.	A	k _r	
mm								mm						-		
120	143	132	158	-	2	1	77	130	-	170	174	2	1	0,139	0,083	
	157	138	180	-	2,1	1,1	90	132	-	203	208	2	1	0,45	0,08	
	178	153	211	-	3	1,5	107	134	-	246	253	2,5	1	1,11	0,09	
130	168	149	193	-	3	1,1	96	144	-	216	222	2,5	1	0,605	0,08	
	189	161	228	-	4	1,5	115	147	-	263	271	3	1,5	1,65	0,09	
140	167	154	185	-	2	1	90	150	-	200	204	2	1	0,263	0,083	
	183	163	210	-	3	1,1	103	154	-	236	243	2,5	1	0,763	0,08	
	202	172	243	-	4	1,5	123	158	-	283	291	3	1,5	2,14	0,09	
150	179	166	198	-	2,1	1,1	96	162	-	213	218	2	1	0,349	0,083	
	197	175	226	-	3	1,1	111	164	-	256	263	2,5	1	1,01	0,08	
	216	183	259	-	4	1,5	131	167	-	303	311	3	1,5	2,74	0,09	
160	211	187	243	-	3	1,1	118	174	-	276	283	2,5	1	1,48	0,08	
	170	205	189	227	-	2,1	1,1	111	182	-	248	253	2	1	0,643	0,083
		227	202	262	-	4	1,5	127	187	-	293	301	3	1,5	2	0,08
243		207	292	-	4	2	147	187	-	343	351	3	2	4,32	0,09	
180	219	201	244	-	2,1	1,1	119	192	-	268	273	2	1	0,912	0,083	
	234	209	269	-	4	1,5	131	197	-	303	311	3	1,5	2,21	0,08	
	257	219	308	-	4	2	156	197	-	363	370	3	2	5,33	0,09	
190	229	211	254	-	2,1	1,1	124	202	-	278	283	2	1	1	0,083	
	250	224	286	-	4	1,5	139	207	-	323	331	3	1,5	2,63	0,08	
	271	231	325	-	5	2	164	210	-	380	390	4	2	6,5	0,09	
200	243	224	270	-	2,1	1,1	145	234	-	285	333	2,5	1,1	1,37	0,083	
	263	235	301	-	4	1,5	146	217	-	343	351	3	1,5	3,2	0,08	
	286	247	340	-	5	2	170	220	-	400	410	4	2	7,5	0,09	
220	267	245	296	-	3	1,1	145	234	-	326	333	2,5	1,1	1,97	0,083	
	291	259	334	-	4	1,5	164	237	-	383	391	3	1,5	5,13	0,08	
240	287	265	316	-	3	1,1	154	254	-	346	353	2,5	1,1	2,23	0,082	
	322	292	361	-	4	1,5	180	257	-	423	431	4	1,5	5,12	0,08	
260	314	289	349	-	4	1,5	171	276	-	373	380	3	1,5	3,94	0,083	
280	334	309	369	-	4	1,5	179	298	-	402	411	3	1,5	4,4	0,083	
	367	328	418	-	5	2	204	300	-	480	489	4	2	11,3	0,08	
300	395	351	450	-	5	2	219	322	-	518	528	4	2	15,2	0,08	

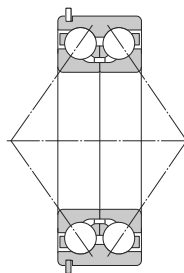
3.2 Double row angular contact ball bearings d 10 – 50 mm



32 A, 33 A



33 D



33 DNRCBM¹⁾

3.2

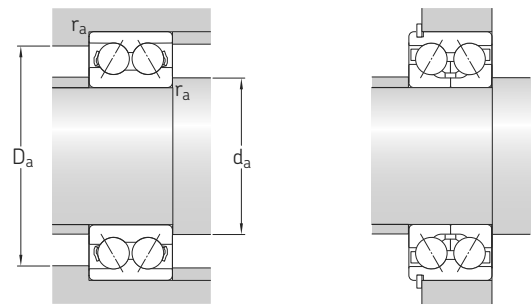


Principal dimensions			Basic load ratings		Fatigue load limit	Speed ratings		Mass	Designations Bearing with metal cage	polyamide cage
d	D	B	C	C ₀		Reference speed	Limiting speed			
mm			kN		kN	r/min		kg	–	
10	30	14	7,61	4,3	0,183	26 000	24 000	0,051	–	▶ 3200 ATN9
12	32	15,9	10,1	5,6	0,24	24 000	22 000	0,058	–	▶ 3201 ATN9
15	35	15,9	11,2	6,8	0,285	22 000	18 000	0,066	–	▶ 3202 ATN9
	42	19	15,1	9,3	0,4	18 000	16 000	0,13	–	▶ 3302 ATN9
17	40	17,5	14,3	8,8	0,365	19 000	16 000	0,096	–	▶ 3203 ATN9
	47	22,2	21,6	12,7	0,54	17 000	14 000	0,18	–	▶ 3303 ATN9
20	47	20,6	20,4	12,9	0,55	16 000	14 000	0,16	▶ 3204 A	▶ 3204 ATN9
	52	22,2	23,6	14,6	0,62	15 000	13 000	0,22	▶ 3304 A	▶ 3304 ATN9
25	52	20,6	21,6	14,3	0,6	14 000	12 000	0,18	▶ 3205 A	▶ 3205 ATN9
	62	25,4	32	20,4	0,865	12 000	11 000	0,35	▶ 3305 A	▶ 3305 ATN9
30	62	23,8	30	20,4	0,865	11 000	10 000	0,29	▶ 3206 A	▶ 3206 ATN9
	72	30,2	42,5	30	1,27	10 000	9 000	0,52	▶ 3306 A	▶ 3306 ATN9
35	72	27	40	28	1,18	10 000	9 000	0,44	▶ 3207 A	▶ 3207 ATN9
	80	34,9	52	35,5	1,5	9 500	8 500	0,74	▶ 3307 A	▶ 3307 ATN9
	80	34,9	52,7	41,5	1,76	9 000	8 000	0,79	3307 DJ1	–
40	80	30,2	48	36,5	1,56	9 000	8 000	0,57	▶ 3208 A	▶ 3208 ATN9
	90	36,5	49,4	41,5	1,76	8 000	7 000	1,2	3308 DNRCBM	–
	90	36,5	64	44	1,86	8 000	7 500	0,93	▶ 3308 A	▶ 3308 ATN9
	90	36,5	68,9	57	2,45	8 000	7 000	1,05	▶ 3308 DMA	–
90	36,5	68,9	57	2,45	8 000	7 000	1,05	3308 DTN9	–	
45	85	30,2	51	39	1,63	8 500	7 500	0,63	▶ 3209 A	▶ 3209 ATN9
	100	39,7	61,8	52	2,2	7 500	6 300	1,5	3309 DNRCBM	–
	100	39,7	75	53	2,24	7 500	6 700	1,25	▶ 3309 A	▶ 3309 ATN9
100	39,7	79,3	69,5	3	7 500	6 300	1,65	3309 DMA	–	
50	90	30,2	51	42,5	1,8	8 000	7 000	0,65	▶ 3210 A	▶ 3210 ATN9
	110	44,4	81,9	69,5	3	6 700	5 600	1,95	3310 DNRCBM	–
	110	44,4	90	64	2,75	6 700	6 000	1,7	▶ 3310 A	▶ 3310 ATN9
	110	44,4	93,6	85	3,6	6 700	5 600	2,2	▶ 3310 DMA	–

SKF Explorer bearing

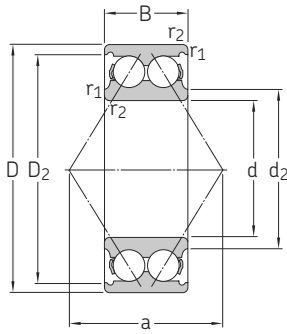
▶ Popular item

¹⁾ For dimensions of snap ring groove and snap ring → table 7, page 395

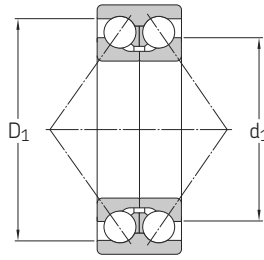


Dimensions							Abutment and fillet dimensions			Calculation factor
d	d ₁ ≈	d ₂ ≈	D ₁ ≈	D ₂ ≈	r _{1,2} min.	a	d _a min.	D _a max.	r _a max.	k _r
mm							mm			–
10	–	15,8	–	25	0,6	16	14,4	25,6	0,6	0,06
12	–	17,2	–	27,7	0,6	19	16,4	27,6	0,6	0,06
15	–	20,2	–	30,7	0,6	21	19,4	30,6	0,6	0,06
	–	23,7	–	35,7	1	24	20,6	36,4	1	0,07
17	–	23,3	–	35	0,6	23	21,4	35,6	0,6	0,06
	–	25,7	–	40,2	1	28	22,6	41,4	1	0,07
20	–	27,7	–	40,9	1	28	25,6	41,4	1	0,06
	–	29,9	–	44	1,1	30	27	45	1	0,07
25	–	32,7	–	45,9	1	30	31	46	1	0,06
	–	35,7	–	53,4	1,1	36	32	55	1	0,07
30	–	38,7	–	55,2	1	36	36	56	1	0,06
	–	39,8	–	64,1	1,1	42	37	65	1	0,07
35	–	45,4	–	63,9	1,1	42	42	65	1	0,06
	–	44,6	–	70,5	1,5	47	44	71	1,5	0,07
	52,8	–	69	–	1,5	76	44	71	1,5	0,095
40	–	47,8	–	72,1	1,1	46	47	73	1	0,06
	61,1	–	77,5	–	1,5	71	49	–	1,5	0,095
	–	50,8	–	80,5	1,5	53	49	81	1,5	0,07
	59,4	–	77,8	–	1,5	84	49	81	1,5	0,095
59,4	–	77,8	–	1,5	84	49	81	1,5	0,095	
45	–	52,8	–	77,1	1,1	46	52	78	1	0,06
	67,9	–	86,6	–	1,5	79	54	–	1,5	0,095
	–	55,6	–	90	1,5	58	54	91	1,5	0,07
70	–	86,4	–	1,5	93	54	91	1,5	0,095	
50	–	57,8	–	82,1	1,1	52	57	83	1	0,06
	74,6	–	96,4	–	2	102	61	–	2	0,095
	–	62	–	99,5	2	65	61	99	2	0,07
	76,5	–	94,2	–	2	102	61	99	2	0,095

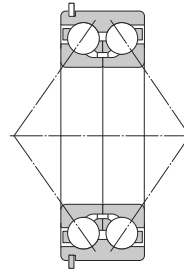
3.2 Double row angular contact ball bearings d 55 – 110 mm



32 A, 33 A



33 D



33 DNRCBM¹⁾

3.2

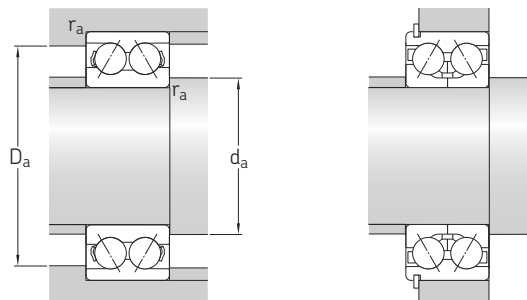


Principal dimensions			Basic load ratings		Fatigue load limit	Speed ratings		Mass	Designations Bearing with metal cage	polyamide cage
d	D	B	C	C ₀		Reference speed	Limiting speed			
mm			kN		kN	r/min		kg	–	
55	100	33,3	60	47,5	2	6 300	6 300	0,91	▶ 3211 A 3311 DNRCBM 3311 DMA	▶ 3211 ATN9
	120	49,2	95,6	83	3,55	5 000	5 300	2,55		–
	120	49,2	111	100	4,3	4 800	5 000	2,8		–
	120	49,2	112	81,5	3,45	5 300	5 300	2,65	3311 A	3311 ATN9
60	110	36,5	73,5	58,5	2,5	6 300	5 600	1,2	▶ 3212 A ▶ 3312 A	▶ 3212 ATN9
	130	54	127	95	4,05	5 600	5 000	2,8		–
65	120	38,1	80,6	73,5	3,1	5 600	4 800	1,75	▶ 3213 A 3313 DNRCBM ▶ 3313 A	–
	140	58,7	138	122	5,1	5 300	4 500	4		–
	140	58,7	146	110	4,55	5 300	4 500	4,1		–
70	125	39,7	88,4	80	3,4	5 600	4 500	1,9	▶ 3214 A ▶ 3314 A	–
	150	63,5	163	125	5	5 000	4 300	5,05		–
75	130	41,3	95,6	88	3,75	5 300	4 500	2,1	▶ 3215 A ▶ 3315 A	–
	160	68,3	176	140	5,5	4 500	4 000	5,55		–
80	140	44,4	106	95	3,9	5 000	4 300	2,65	▶ 3216 A ▶ 3316 A	–
	170	68,3	193	156	6	4 300	3 800	6,8		–
85	150	49,2	124	110	4,4	4 500	3 800	3,4	▶ 3217 A ▶ 3317 A	–
	180	73	208	176	6,55	4 000	3 600	8,3		–
90	160	52,4	130	120	4,55	4 300	3 600	4,15	▶ 3218 A ▶ 3318 A	–
	190	73	208	180	6,4	3 800	3 400	9,25		–
95	170	55,6	159	146	5,4	4 000	3 400	5	▶ 3219 A ▶ 3319 A	–
	200	77,8	240	216	7,5	3 600	3 200	11		–
100	180	60,3	178	166	6	3 800	3 200	6,1	▶ 3220 A ▶ 3320 A	–
	215	82,6	255	255	8,65	3 400	2 800	13,5		–
110	200	69,8	212	212	7,2	3 400	2 800	8,8	▶ 3222 A 3322 A	–
	240	92,1	291	305	9,8	3 000	2 600	19		–

SKF Explorer bearing

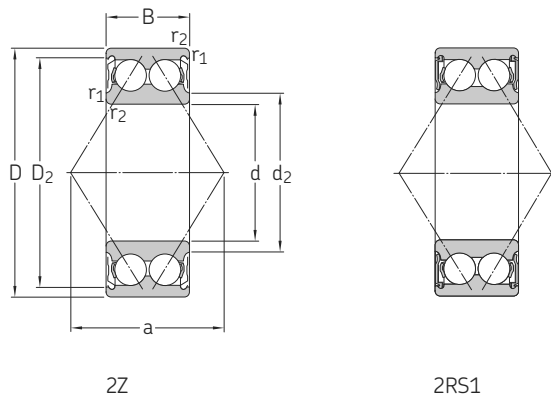
▶ Popular item

¹⁾ For dimensions of snap ring groove and snap ring → table 7, page 395



Dimensions							Abutment and fillet dimensions			Calculation factor
d	d ₁ ≈	d ₂ ≈	D ₁ ≈	D ₂ ≈	r _{1,2} min.	a	d _a min.	D _a max.	r _a max.	k _r
mm							mm			–
55	–	63,2	–	92,3	1,5	57	63	91	1,5	0,06
	81,5	–	106	–	2	97	66	–	2	0,095
	81,4	–	105	–	2	114	66	109	2	0,095
	–	68,4	–	110	2	72	66	109	2	0,07
60	74,4	–	96,2	–	1,5	63	69	101	1,5	0,06
	84,2	–	110	–	2,1	78	72	118	2	0,07
65	84,9	–	103	–	1,5	71	74	111	1,5	0,06
	95	–	125	–	2,1	114	77	–	2	0,095
	89,8	–	116	–	2,1	84	77	128	2	0,07
70	88,5	–	108	–	1,5	74	79	116	1,5	0,06
	96,5	–	125	–	2,1	89	82	138	2	0,07
75	92	–	112	–	1,5	77	84	121	1,5	0,06
	103	–	135	–	2,1	97	87	148	2	0,07
80	97,6	–	120	–	2	82	91	129	2	0,06
	109	–	144	–	2,1	101	92	158	2	0,07
85	103	–	136	–	2	88	96	139	2	0,06
	116	–	153	–	3	107	99	166	2,5	0,07
90	111	–	137	–	2	94	101	149	2	0,06
	123	–	160	–	3	112	104	176	2,5	0,07
95	119	–	146	–	2,1	101	107	158	2	0,06
	127	–	176	–	3	127	109	186	2,5	0,07
100	126	–	162	–	2,1	107	112	168	2	0,06
	135	–	180	–	3	127	114	201	2,5	0,07
110	139	–	174	–	2,1	119	122	188	2	0,06
	152	–	201	–	3	142	124	226	2,5	0,07

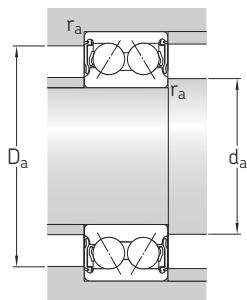
3.3 Capped double row angular contact ball bearings d 10 – 75 mm



3.3

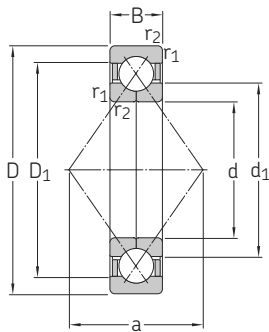


Principal dimensions			Basic load ratings		Fatigue load limit	Limiting speed		Mass	Designations	
d	D	B	dynamic	static		Bearing with shields	seals		Bearing with shields	seals
mm			kN		kN	r/min		kg	–	
10	30	14	7,61	4,3	0,183	24 000	17 000	0,051	3200 A-ZZ	3200 A-2RS1
12	32	15,9	10,1	5,6	0,24	22 000	15 000	0,058	3201 A-ZZ	3201 A-2RS1
15	35	15,9	11,2	6,8	0,285	18 000	14 000	0,066	3202 A-ZZ	3202 A-2RS1
	42	19	15,1	9,3	0,4	16 000	12 000	0,13	3302 A-ZZ	3302 A-2RS1
17	40	17,5	14,3	8,8	0,365	16 000	12 000	0,1	3203 A-ZZ	3203 A-2RS1
	47	22,2	21,6	12,7	0,54	14 000	11 000	0,18	3303 A-ZZ	3303 A-2RS1
20	47	20,6	20,4	12,9	0,55	14 000	10 000	0,16	▶ 3204 A-ZZ	▶ 3204 A-2RS1
	52	22,2	23,6	14,6	0,62	13 000	9 000	0,22	3304 A-ZZ	▶ 3304 A-2RS1
25	52	20,6	21,6	14,3	0,6	12 000	8 500	0,18	▶ 3205 A-ZZ	▶ 3205 A-2RS1
	62	25,4	32	20,4	0,865	11 000	7 500	0,35	▶ 3305 A-ZZ	▶ 3305 A-2RS1
30	62	23,8	30	20,4	0,865	10 000	7 500	0,29	▶ 3206 A-ZZ	▶ 3206 A-2RS1
	72	30,2	42,5	30	1,27	9 000	6 300	0,52	▶ 3306 A-ZZ	▶ 3306 A-2RS1
35	72	27	40	28	1,18	9 000	6 300	0,44	▶ 3207 A-ZZ	▶ 3207 A-2RS1
	80	34,9	52	35,5	1,5	8 500	6 000	0,74	3307 A-ZZ	▶ 3307 A-2RS1
40	80	30,2	48	36,5	1,56	8 000	5 600	0,57	▶ 3208 A-ZZ	▶ 3208 A-2RS1
	90	36,5	64	44	1,86	7 500	5 000	0,93	▶ 3308 A-ZZ	▶ 3308 A-2RS1
45	85	30,2	51	39	1,63	7 500	5 300	0,63	▶ 3209 A-ZZ	▶ 3209 A-2RS1
	100	39,7	75	53	2,24	6 700	4 800	1,25	3309 A-ZZ	▶ 3309 A-2RS1
50	90	30,2	51	42,5	1,8	7 000	4 800	0,65	▶ 3210 A-ZZ	▶ 3210 A-2RS1
	110	44,4	90	64	2,75	6 000	4 300	1,7	▶ 3310 A-ZZ	▶ 3310 A-2RS1
55	100	33,3	60	47,5	2	6 300	4 500	0,91	3211 A-ZZ	▶ 3211 A-2RS1
	120	49,2	112	81,5	3,45	5 300	3 800	2,65	3311 A-ZZ	▶ 3311 A-2RS1
60	110	36,5	73,5	58,5	2,5	5 600	4 000	1,2	3212 A-ZZ	▶ 3212 A-2RS1
	130	54	127	95	4,05	5 000	–	2,8	3312 A-ZZ	–
65	120	38,1	80,6	73,5	3,1	4 800	3 600	1,75	3213 A-ZZ	▶ 3213 A-2RS1
	140	58,7	146	110	4,55	4 500	–	4,1	3313 A-ZZ	–
70	125	39,7	88,4	80	3,4	4 500	–	1,9	3214 A-ZZ	–
	150	63,5	163	125	5	4 300	–	5,05	3314 A-ZZ	–
75	130	41,3	95,6	88	3,75	4 500	–	2,1	▶ 3215 A-ZZ	–
	160	68,3	176	140	5,5	4 000	–	5,6	3315 A-ZZ	–

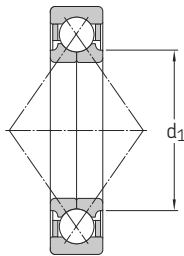


Dimensions					Abutment and fillet dimensions				Calculation factor
d	d ₂ ≈	D ₂ ≈	r _{1,2} min.	a	d _a min.	d _a max.	D _a max.	r _a max.	k _r
mm					mm				–
10	15,8	25	0,6	16	14,4	15,5	25,6	0,6	0,06
12	17,2	27,7	0,6	19	16,4	17	27,6	0,6	0,06
15	20,2 23,7	30,7 35,7	0,6 1	21 24	19,4 20,6	20 23,5	30,6 36,4	0,6 1	0,06 0,07
17	23,3 25,7	35 40,2	0,6 1	23 28	21,4 22,6	23 25,5	35,6 41,4	0,6 1	0,06 0,07
20	27,7 29,9	40,9 44	1 1,1	28 30	25,6 27	27,5 29,5	41,4 45	1 1	0,06 0,07
25	32,7 35,7	45,9 53,4	1 1,1	30 36	30,6 32	32,5 35,5	46,4 55	1 1	0,06 0,07
30	38,7 39,8	55,2 64,1	1 1,1	36 42	35,6 37	38,5 39,5	56 65	1 1	0,06 0,07
35	45,4 44,6	63,9 70,5	1,1 1,5	42 47	42 44	45 44,5	65 71	1 1,5	0,06 0,07
40	47,8 50,8	72,1 80,5	1,1 1,5	46 53	47 49	48 50	73 81	1 1,5	0,06 0,07
45	52,8 55,6	77,1 90	1,1 1,5	46 58	52 54	52 91	78 91	1 1,5	0,06 0,07
50	57,8 62	82,1 99,5	1,1 2	52 65	57 61	57 61	83 99	1 2	0,06 0,07
55	63,2 68,4	92,3 110	1,5 2	57 72	63 66	63 68	91 109	1,5 2	0,06 0,07
60	68,8 73,4	101 118	1,5 2,1	63 78	69 72	68 73	101 118	1,5 2	0,06 0,07
65	77,5 79,2	111 128	1,5 2,1	71 84	74 77	76 78	111 128	1,5 2	0,06 0,07
70	82,5 86,5	116 137	1,5 2,1	74 89	79 82	82 84	116 138	1,5 2	0,06 0,07
75	87,5 95,4	121 147	1,5 2,1	77 97	84 87	84 88	121 148	1,5 2	0,06 0,07

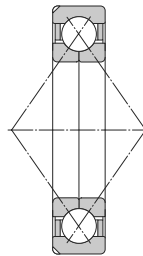
3.4 Four-point contact ball bearings d 15 – 65 mm



Basic design



SKF Explorer bearing



Bearing with locating slots

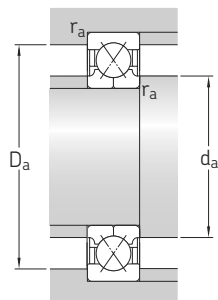


Principal dimensions			Basic load ratings		Fatigue load limit	Limiting speed	Mass	Designations	
d	D	B	dynamic	static				C	C_0
mm			kN		kN	r/min	kg	-	
15	35	11	12,7	8,3	0,355	36 000	0,062	QJ 202 N2MA	-
17	40	12	17	11,4	0,48	30 000	0,082	QJ 203 N2MA	-
	47	14	23,4	15	0,64	28 000	0,14	QJ 303 N2MA	-
20	52	15	32	21,6	0,93	24 000	0,18	QJ 304 N2MA	▶ QJ 304 MA
	52	15	32	21,6	0,93	24 000	0,18	QJ 304 N2PHAS	-
25	52	15	27	21,2	0,9	22 000	0,16	QJ 205 N2MA	-
	62	17	42,5	30	1,27	20 000	0,29	QJ 305 N2MA	QJ 305 MA
30	62	16	37,5	30,5	1,29	19 000	0,24	QJ 206 N2MA	▶ QJ 206 MA
	72	19	53	41,5	1,76	17 000	0,42	QJ 306 N2MA	▶ QJ 306 MA
	72	19	53	41,5	1,76	17 000	0,42	QJ 306 N2PHAS	-
35	72	17	49	41,5	1,76	17 000	0,35	QJ 207 N2MA	-
	80	21	64	51	2,16	15 000	0,57	QJ 307 N2MA	▶ QJ 307 MA
	80	21	64	51	2,16	15 000	0,57	QJ 307 N2PHAS	-
40	80	18	56	49	2,08	15 000	0,45	-	▶ QJ 208 MA
	90	23	78	64	2,7	14 000	0,78	QJ 308 N2MA	▶ QJ 308 MA
	90	23	78	64	2,7	14 000	0,78	QJ 308 N2PHAS	-
45	85	19	63	56	2,36	14 000	0,52	-	▶ QJ 209 MA
	100	25	100	83	3,55	12 000	1,05	QJ 309 N2MA	▶ QJ 309 MA
	100	25	100	83	3,55	12 000	1,05	QJ 309 N2PHAS	QJ 309 PHAS
50	90	20	65,5	61	2,6	13 000	0,59	-	▶ QJ 210 MA
	110	27	118	100	4,25	11 000	1,35	-	▶ QJ 310 MA
	110	27	118	100	4,25	11 000	1,35	-	QJ 310 PHAS
55	100	21	85	83	3,55	11 000	0,77	QJ 211 N2MA	▶ QJ 211 MA
	120	29	137	118	5	10 000	1,75	QJ 311 N2MA	▶ QJ 311 MA
60	110	22	96,5	93	4	10 000	0,99	QJ 212 N2PHAS	-
	110	22	96,5	93	4	10 000	0,99	QJ 212 N2MA	▶ QJ 212 MA
	130	31	156	137	5,85	9 000	2,15	QJ 312 N2MA	▶ QJ 312 MA
	130	31	156	137	5,85	9 000	2,15	-	▶ QJ 312 PHAS
65	120	23	110	112	4,75	9 500	1,2	QJ 213 N2PHAS	-
	120	23	110	112	4,75	9 500	1,2	QJ 213 N2MA	▶ QJ 213 MA
	140	33	176	156	6,55	8 500	2,7	QJ 313 N2PHAS	-
	140	33	176	156	6,55	8 500	2,7	-	▶ QJ 313 MA

SKF Explorer bearing

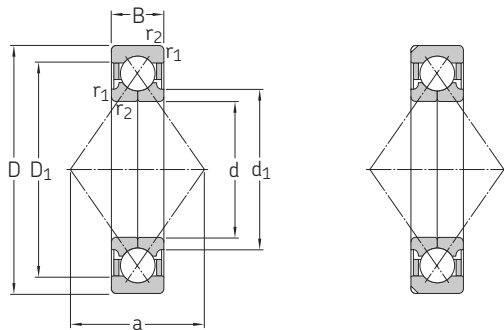
▶ Popular item

1) For dimensions of locating slots → table 1, page 387



Dimensions					Abutment and fillet dimensions			Calculation factor
d	d ₁ ≈	D ₁ ≈	r _{1,2} min.	a	d _a min.	D _a max.	r _a max.	A
mm					mm			–
15	22	28,1	0,6	18	19,2	30,8	0,6	0,000 257
17	23,5	32,5	0,6	20	21,2	35,8	0,6	0,000 427
	27,7	36,3	1	22	22,6	41,4	1	0,00087
20	27,5	40,8	1,1	25	27	45	1	0,00143
	27,5	40,8	1,1	25	27	45	1	0,00143
25	31,5	43	1	27	30,6	46,4	1	0,00126
	34	49	1,1	30	32	55	1	0,00278
30	37,5	50,8	1	32	35,6	56	1	0,00256
	40,5	58,2	1,1	36	37	65	1	0,00508
	40,5	58,2	1,1	36	37	65	1	0,00508
35	44	59	1,1	37	42	65	1	0,00473
	46,2	64,3	1,5	40	44	71	1,5	0,00744
	46,2	64,3	1,5	40	44	71	1,5	0,00744
40	49,5	66	1,1	42	47	73	1	0,0066
	52	72,5	1,5	46	49	81	1,5	0,0118
	52	72,5	1,5	46	49	81	1,5	0,0118
45	54,5	72	1,1	46	52	78	1	0,00871
	58	81,2	1,5	51	54	91	1,5	0,0202
	58	81,2	1,5	51	54	91	1,5	0,0202
50	59,5	76,5	1,1	49	57	83	1	0,0103
	65	90	2	56	61	99	2	0,029
	65	90	2	56	61	99	2	0,029
55	66	84,7	1,5	54	64	91	1,5	0,0173
	70,5	97,8	2	61	66	109	2	0,0404
60	72	93	1,5	60	69	101	1,5	0,0242
	72	93	1,5	60	69	101	1,5	0,0242
	77	106	2,1	67	72	118	2	0,0549
	77	106	2,1	67	72	118	2	0,0549
65	78,5	101	1,5	65	74	111	1,5	0,033
	78,5	101	1,5	65	74	111	1,5	0,033
	82,5	115	2,1	72	77	128	2	0,0731
	82,5	115	2,1	72	77	128	2	0,0731

3.4 Four-point contact ball bearings d 70 – 150 mm



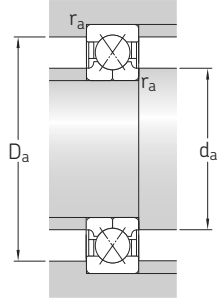
Bearing with locating slots

Principal dimensions			Basic load ratings		Fatigue load limit	Limiting speed	Mass	Designations	
d	D	B	dynamic	static				Bearing with locating slots ¹⁾	without locating slots
mm			kN		kN	r/min	kg	–	
70	125	24	120	122	5,2	9 000	1,3	▶ QJ 214 N2MA	QJ 214 MA
	125	24	120	122	5,2	9 000	1,3	QJ 214 N2PHAS	–
	150	35	200	180	7,35	8 000	3,15	QJ 314 N2MA	▶ QJ 314 MA
	150	35	200	180	7,35	8 000	3,15	QJ 314 N2PHAS	–
75	130	25	125	132	5,6	8 500	1,45	QJ 215 N2MA	▶ QJ 215 MA
	130	25	125	132	5,6	8 500	1,45	QJ 215 N2PHAS	–
	160	37	216	200	7,8	7 500	3,9	▶ QJ 315 N2MA	–
	160	37	216	200	7,8	7 500	3,9	QJ 315 N2PHAS	–
80	140	26	146	156	6,4	8 000	1,85	▶ QJ 216 N2MA	▶ QJ 216 MA
	170	39	232	228	8,65	7 000	4,6	▶ QJ 316 N2MA	–
	170	39	232	228	8,65	7 000	4,6	QJ 316 N2PHAS	–
85	150	28	156	173	6,7	7 500	2,25	▶ QJ 217 N2MA	▶ QJ 217 MA
	180	41	250	255	8,65	6 700	5,45	▶ QJ 317 N2MA	–
90	160	30	186	200	7,65	7 000	2,75	▶ QJ 218 N2MA	–
	190	43	285	305	11	6 300	6,45	▶ QJ 318 N2MA	–
	190	43	285	305	11	6 300	6,45	QJ 318 N2PHAS	–
95	170	32	212	232	8,5	6 700	3,35	▶ QJ 219 N2MA	–
	200	45	305	340	11,8	6 000	7,45	▶ QJ 319 N2MA	–
	200	45	305	340	11,8	6 000	7,45	QJ 319 N2PHAS	–
100	180	34	236	265	9,5	6 300	4,05	▶ QJ 220 N2MA	–
	215	47	345	400	13,7	5 600	9,3	▶ QJ 320 N2MA	–
110	200	38	280	325	11,2	5 600	5,6	▶ QJ 222 N2MA	–
	240	50	390	480	15,3	4 800	12,5	▶ QJ 322 N2MA	–
120	215	40	300	365	12	5 000	6,95	▶ QJ 224 N2MA	–
	260	55	415	530	16,3	4 500	16	▶ QJ 324 N2MA	–
130	230	40	310	400	12,7	4 800	7,75	▶ QJ 226 N2MA	–
	280	58	455	610	18	4 000	19,5	▶ QJ 326 N2MA	–
140	250	42	345	475	14,3	4 300	9,85	▶ QJ 228 N2MA	–
	300	62	500	695	20	3 800	24	▶ QJ 328 N2MA	–
150	270	45	400	570	16,6	4 000	12,5	▶ QJ 230 N2MA	–
	320	65	530	765	21,2	3 600	29	QJ 330 N2MA	–

SKF Explorer bearing

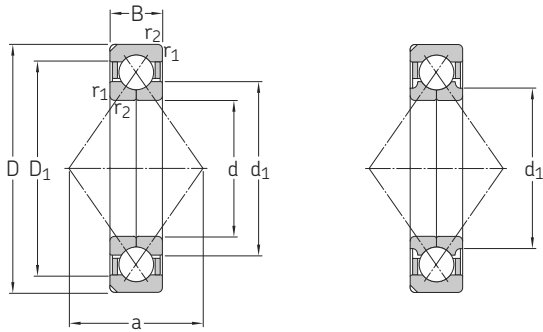
▶ Popular item

1) For dimensions of locating slots → table 1, page 387



Dimensions					Abutment and fillet dimensions			Calculation factor
d	d ₁ ≈	D ₁ ≈	r _{1,2} min.	a	d _a min.	D _a max.	r _a max.	A
mm					mm			-
70	83,5	106	1,5	68	79	116	1,5	0,04
	83,5	106	1,5	68	79	116	1,5	0,04
	89	123	2,1	77	82	138	2	0,0954
	89	123	2,1	77	82	138	2	0,0954
75	88,5	112	1,5	72	84	121	1,5	0,0453
	88,5	112	1,5	72	84	121	1,5	0,0453
	104	131	2,1	82	87	148	2	0,122
	104	131	2,1	82	87	148	2	0,122
80	95,3	120	2	77	91	130	2	0,0629
	111	139	2,1	88	92	158	2	0,155
	111	139	2,1	88	92	158	2	0,155
85	100	128	2	83	96	139	2	0,0768
	117	148	3	93	99	166	2,5	0,193
90	114	136	2	88	101	149	2	0,106
	124	156	3	98	104	176	2,5	0,26
	124	156	3	98	104	176	2,5	0,26
95	120	145	2,1	93	107	158	2	0,138
	131	165	3	103	109	186	2,5	0,317
	131	165	3	103	109	186	2,5	0,317
100	127	153	2,1	98	112	168	2	0,176
	139	176	3	110	114	201	2	0,442
110	141	169	2,1	109	122	188	2	0,277
	154	196	3	123	124	226	2,5	0,635
120	152	183	2,1	117	132	203	2	0,354
	169	211	3	133	134	246	2,5	0,785
130	165	195	3	126	144	216	2,5	0,411
	182	227	4	144	147	263	3	1,06
140	179	211	3	137	154	236	2,5	0,556
	196	244	4	154	158	282	3	1,4
150	194	226	3	147	164	256	2,5	0,793
	211	259	4	165	167	303	3	1,65

3.4 Four-point contact ball bearings d 160 – 200 mm



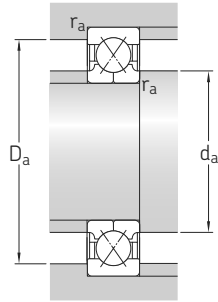
SKF Explorer bearing

Principal dimensions			Basic load ratings		Fatigue load limit	Limiting speed	Mass	Designations Bearing with locating slots ¹⁾	without locating slots
d	D	B	C	C ₀					
mm			kN		kN	r/min	kg	–	
160	290	48	450	670	19	3 800	15,5	▶ QJ 232 N2MA	–
	340	68	570	880	23,6	3 400	34,5	▶ QJ 332 N2MA	–
170	310	52	455	720	20	3 400	19,5	▶ QJ 234 N2MA	–
	360	72	655	1 040	27	3 200	41,5	▶ QJ 334 N2MA	–
180	320	52	475	765	20,8	3 400	20,5	▶ QJ 236 N2MA	–
	380	75	680	1 100	28	3 000	47,5	QJ 336 N2MA	–
190	340	55	510	850	22,4	3 200	23,5	QJ 238 N2MA	–
	400	78	702	1 160	28,5	2 800	49	QJ 338 N2MA	–
200	360	58	540	915	23,2	3 000	28,5	QJ 240 N2MA	–

SKF Explorer bearing

▶ Popular item

¹⁾ For dimensions of locating slots → table 1, page 387



Dimensions					Abutment and fillet dimensions			Calculation factor
d	d ₁ ≈	D ₁ ≈	r _{1,2} min.	a	d _a min.	D _a max.	r _a max.	A
mm					mm			-
160	204	243	3	158	174	276	2,5	1,1
	224	276	4	175	177	323	3	2,12
170	204	243	4	168	187	293	3	1,26
	237	293	4	186	187	343	3	2,92
180	231	269	4	175	197	303	3	1,39
	252	309	4	196	197	363	3	3,38
190	244	285	4	185	207	323	3	1,77
	263	326	5	207	210	380	4	4,45
200	258	302	4	196	217	363	3	2,33